

**ITS QUICKER OFF THE MARK**

with a

**SHORROCK  
SUPERCHARGER**

Courtesy Al Moss  
May, 2008

over

20

years of record breaking success . . .

Shorrock have the distinction of being chosen for supercharging engines holding over 60% of the total "fastest-ever" world class record attempts.

1937



As early as 1937, Shorrock Superchargers have been fitted to small cars, the M.G. range in particular. Subsequent world records by this famous car were achieved with a Shorrock supercharged engine. The most noteworthy was in May, 1939, when the M.G., then driven by the late Lt.-Col. A. T. ("Goldie") Gardner, at Dessau, Germany, was the first car in the world, in Class G, to exceed 200 m.p.h.

1957



Shorrock are also proud to have been associated with the fabulous success of the 1½ litre supercharged M.G. Ex. 181.

Fitted with a supercharger specially developed from a standard unit the "M.G. Special," driven by Stirling Moss at Utah, broke five International Class F records, including the flying kilometre at 245.64 m.p.h.

Again, in the same month, the B.M.C. Development Project Ex. 179 with co-drivers Tommy Wisdom and David Ash, captured six International Class G records with a blown engine. These records included driving for six hours at an average speed of 132.3 m.p.h., and the 1,000 Km. at 131.84 m.p.h.

1959



In 1959 Shorrock were proud to be associated with the phenomenal success of the Austin Healey Sprite. Driven by T. H. Wisdom, Ed Leavens, and Gus Ehrman, it put up a fantastic performance in Class G smashing 15 International records and 52 American records—maximum speed 145.56 m.p.h. and 12-hour endurance at 138.75 m.p.h.



In the same month Phil Hill captured 6 new International Class E records in the supercharged M.G. 181 including the Flying Mile at 254.53 m.p.h.—Shorrock Supercharged again.

today . .

These records establish Shorrock as the first name in Superchargers with a wealth of experience that has led to perfecting superchargers not only for racing and record attempts, but for you the average motorist.

Backed by the immense resources of the Owen Organisation, with whom they are associated, Shorrock produce superchargers for most makes of modern cars.

Courtesy Al Moss  
May, 2008

# Mr. Shorrock . . . . .

## and The Everyday Motorist



### What actually is supercharging?

The function of a supercharger is to allow a larger quantity, by weight of petrol-air mixture to be fed to the engine than could be induced in the normal way.

In other words, the engine receives its input of air at a pressure higher than atmospheric pressure, which is virtually equivalent to increasing the swept volume of the engine.

Thus, an engine of 1,500 c.c. capacity supercharged at a pressure of 5 lbs./sq. in., has the same effective capacity as an engine of 2,000 c.c. swept volume, since it is receiving its charge at atmospheric pressure (14.74 lbs./sq. in.), plus 5 lbs./sq. in. or at approximately one-third greater pressure.

To obtain the fullest benefit, it is necessary to employ a supercharger which in itself will operate efficiently over a wide speed range with the minimum absorption of power.

It is to this end that the SHORROCK supercharger was designed.

### I always thought supercharging was for racing cars only?

I agree that in the past supercharging has been associated in the minds of the public with racing cars. In fact, many enthusiasts have fitted SHORROCK to their cars for sprint trials and long distance events with outstanding results. Many world records have been achieved with cars supercharged by SHORROCK. Our experience over the years has largely been built up by stringent tests on the race track. All this experience, however, has been of immense value to perfect superchargers which can be used safely, efficiently and economically by the general motoring public.

### Why are they not offered as optional equipment by the motor manufacturer?

All cars are produced with engines of specified basic ratings and a supercharger is considered to be an extra appliance for boosting the engine by pressure induction.

For the motorists who wants to enjoy the benefits of extra power and performance, particularly with the smaller car, most car manufacturers recommend them to Shorrock.

In our opinion, the many advantages now proved by supercharging should lead to even greater popularity in the future, which may induce motor manufacturers themselves to offer the appliance as an "optional," or at least allow for its installation in the basic design of their engine layout.

### In what way does it improve performance?

The Shorrock installation provides substantially more power (up to 50%). It gives improved engine flexibility which means less gear changing at all times. Many more hills can be taken "in top" and all at higher speeds if necessary. Snappier "off-the-mark" acceleration is obtained and the increased power considerably raises the average cruising speed.

### What about fuel consumption, and do I need special grades?

If a supercharged car is driven normally, that is without taking advantage of the extra power for increased speed and top gear performance, then fuel consumption is not affected and in some instances is often reduced. By using the supercharger to its full effect, however, a slight increase in fuel consumption is only to be expected. This varies from 10%—15%. Measuring performance and economy, however, against bigger cars of higher basic rating, this slight increase is comparatively negligible. Standard premium grade fuels are entirely suitable.

### Will fitting a supercharger impair the basic engine?

On the contrary, low pressure charging as used by Shorrock apart from increasing thermal efficiency has been proved to prolong the life of exhaust valves and also to reduce cylinder wear. All cylinders operate with a mixture of equal strength. This even distribution gives a longer life to the engine and prevents local mixture starvation to any one cylinder, often a cause of inadequate lubrication on starting is also a common cause of bore wear. The Shorrock supercharger supplies all cylinders with a surplus of oil collected in the casing upon starting which provides upper cylinder lubrication when it is most needed.

### Should I need a higher back axle ratio?

For normal use, the average back axle and gear ratios are quite satisfactory. For competition work, it may in some cases be desirable to modify the axle ratio.

### I thought superchargers were noisy?

The noise often associated with superchargers can be caused by pressure differences at the discharge port. The Shorrock vane type compressor has the advantage of reducing noise, the charge being compressed internally and there is no back flow of air when the port is uncovered. Pulsations are reduced to a minimum and by fitting a normal type of air cleaner, the operation is virtually noiseless at all speeds.

### I believe they are good for high altitudes?

Indeed, yes. Supercharging is the only means of compensating for the loss of power inevitable with lowered air density. Quite a feature, particularly for Continental touring and, of course, for the export market generally.

### Will the supercharger fit any car, and are any modifications necessary?

The Shorrock "blower" can be fitted to most cars where the engine layout provides the necessary room. We publish a list of current cars suitable for the Shorrock installation. For older cars, we will gladly advise as to suitability.

No modification is necessary to the engine. The complete installation can be fitted in approximately half-a-day. A new carburettor, however, is necessary which, together with manifold pipes, fitting brackets, pulleys and belts, is supplied inclusive with the Supercharger. Installation may be effected quite easily by any competent garage or owner-driver. Your existing petrol pump, too, is quite adequate. We recommend that standard "touring" plugs be replaced by plugs of the "sports" type.

Finally, should you change your car, the Supercharger can be transferred, providing the engines are of reasonably similar capacities.

### Is a supercharger worth the outlay?

If you mean the SHORROCK, yes. It's a precision engineered job backed by twenty years of research in the Supercharger field and proved under the most exacting trials. We are, of course, associated with the Rubery Owen Organisation and with them enjoy the closest relationships with the whole of the Motor Industry. You, however, are the motorist and the expense of a Supercharger is for you to consider. The joy of owning and driving a Shorrock supercharged car approaching the performance of some of the big boys has to be experienced to be believed. The relative expenditure on a supercharger as against the price difference in the larger car is surely the factor to be considered.

Thanks a lot, Mr. Shorrock. I see now that your blower concerns the ordinary motorist like me, not only the enthusiast. You've supercharged me alright — I'll be seeing you again.

Courtesy of Moss  
May, 2008 3

# Pressure-Charging I.C. Engines

## ... some basic principles and advantages

It will no doubt be of interest to those people wishing to improve the all round performance and flexibility of their cars, whether large or small horse power to gain some small insight into the principles involved in "Pressure Charging" as this system is called when applied to the everyday motor car, or "Supercharging," when applied to obtain the absolute maximum output in the case of a racing car.

In an internal combustion engine the amount of power developed is in direct proportion to the weight of fuel consumed in a given time, the fuel being mixed with the correct volume of air to ensure its complete combustion in the engine.

With a "normally aspirated" engine, that is one which is *not* supercharged, the power is limited to the amount of air that can be sucked into the cylinders on the induction stroke, as this determines the weight of fuel that can be burnt with it.

The piston on its downward stroke (i.e., the induction stroke) creates a partial vacuum in the induction pipe which causes air to be drawn through the carburettor to the cylinder, collecting on its way through the carburettor the correct amount of fuel.

However, if the piston were to remain stationary at the bottom of its stroke, the cylinder would only then fill with mixture, but unfortunately as under working conditions there is only a fraction of a second for this operation to take place, the cylinder is at best only partially filled with the petrol-air mixture.

**It is to overcome these inherent limitations in the normally (or atmospherically) aspirated engine that pressure charging is employed. An engine equipped with the Shorrock pressure induction system is free from the foregoing disadvantages, in fact it gives much improved power, flexibility, acceleration and 'top gear' performance.**

With the SHORROCK-Supercharged engine operating at a maximum boost pressure of 5 lbs./sq. in., air is drawn through the carburettor into a compressor, the capacity of which is so arranged that it draws a volume of air equal to the FULL SWEEPED VOLUME (or capacity) of the engine PLUS ONE-THIRD.

Since the compressor is positively driven from the engine crankshaft, no matter what the engine speed, the induction pipe is full of the correct air-petrol mixture UNDER PRESSURE, thus ensuring a perfectly steady flow into the cylinders which results in remarkable flexibility at all engine speeds enabling the car to be driven at walking speed in top gear.

Since the cylinders receive their full volume, plus one third from the compressor, the power output of the engine is increased proportionately, i.e., 33% at least. Pressure charging has not been more universally adopted in the past, as it is only comparatively recently that a compressor suitable for this application has been available. To meet the requirements of the modern car it is essential that the compressor should be quiet in operation and be as reliable as any other part of the engine.

Supercharging has, of course, been employed for a number of years in connection with racing cars where requirements are somewhat different from the ordinary pleasure car.

With the racing car it is generally a question of obtaining the maximum amount of power possible at "full throttle"—increased power and flexibility at lower speeds being of little comparative consequence and as such, in designing superchargers for these conditions no particular attention was given to obtain high efficiency at low engine speed.

In the past, to obtain even moderate results at the "bottom end" of the ordinary car, a supercharger had to be employed which gave too high a boost at maximum speeds causing troubles and annoyances such as burnt plugs and exhaust valves, blown cylinder head gaskets, etc.

The present Shorrock supercharger with many exclusive features in its design, is eminently suitable for pressure charging the normal car in addition to the supercharging of racing cars, having been proved in both spheres to be a unit of remarkable efficiency.

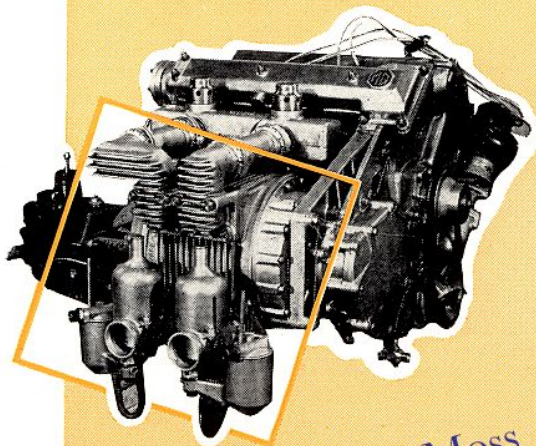

Shorrock Superchargers are the outcome of many years experience in the design of high efficiency compressors, which has resulted in the production of a range of superchargers with remarkably high adiabatic efficiency, low power absorption and which operate with a complete absence of mechanical noise.

The characteristics of these superchargers make them eminently suitable, not only for cars, but for road transport vehicles of all types propelled by either petrol or compression ignition engines and for powered water craft. In the industrial field also, Shorrock compressors and exhausters have universal application.

The high volumetric efficiency throughout the speed range enables maximum torque and power to be obtained. Another feature of the "Shorrock" is the possibility of using high boost pressures without using multi-stage compression. The complete range of superchargers covers engine requirements from 850 c.c. to 10 litres depending upon boost pressures required and operating speed. The lubrication system has received particular attention and is fully automatic.

Courtesy Al Moss  
May, 2008

# PRINCIPLES OF THE SHORROCK SUPERCHARGER

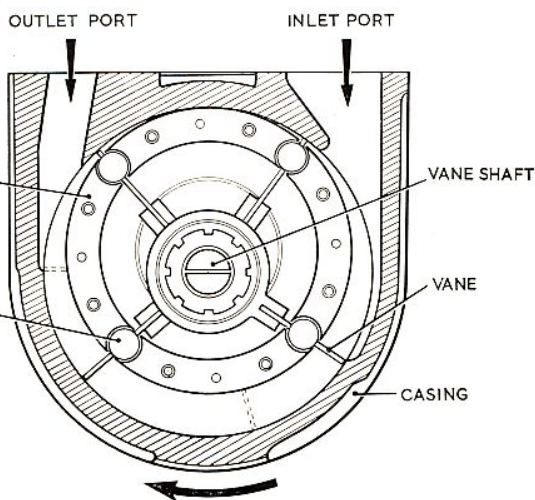
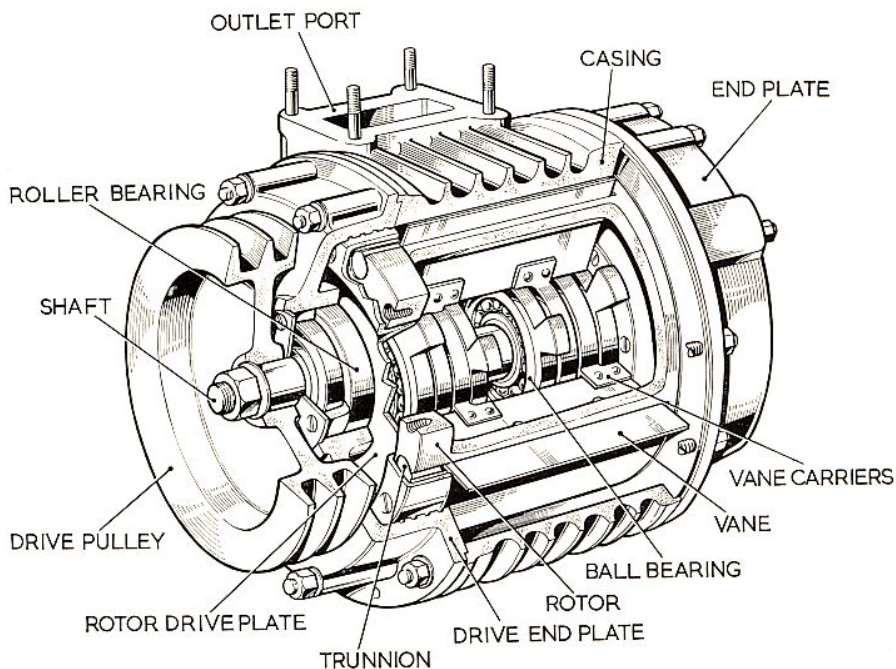
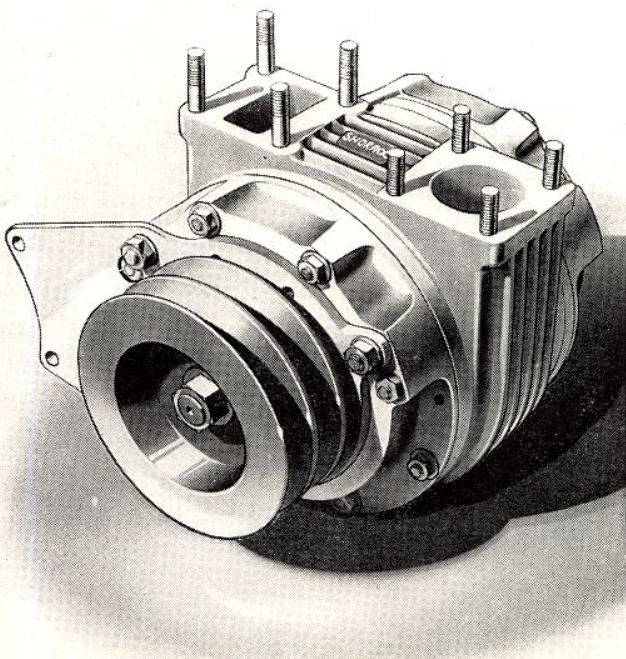

The Shorrock Supercharger is a positive displacement eccentric-drum-type compressor employing four vanes.

The vanes are mounted radially to the compressor casing, each vane being carried by two ball journals mounted on a shaft of ample dimensions concentric with the outer casing.

The vanes are impelled by the internal rotor which is mounted eccentrically to the outer casing and through which the vanes pass.

The angular motion of the vanes relative to the rotor is accommodated by specially designed trunnions.

This construction makes practical the very fine clearances necessary for high efficiencies, since the vanes being mounted radially to the casing and anchored by the vane shaft cannot come into direct contact with the casing and can be run at very high speeds.

The four vanes passing through the rotor and having such very fine clearances between their extremities and the casing and end plates, virtually sub-divide the crescent shaped chamber into four separate chambers. The inlet port of the supercharger is so positioned that as one of the chambers receives its full volume of air, the adjacent chamber (on the inlet side of the unit) is increasing in volume and creating a vacuum at the inlet port.

Immediately the vanes have reached the position where the chamber between them contains the maximum volume, the volume between the vanes diminishes as the space between the rotor and the casing becomes less, thus compressing the charge within the supercharger itself before releasing it through the outlet port into the engine manifold.

Lubrication is fully automatic and only a very small quantity of lubricant is required for the supercharger to function with complete reliability.

The supercharger is preferably mounted on the inlet manifold side of the engine and driven by twin vee-belts from the front end of the crankshaft, the installation design being such that it can confidently be carried out by any competent garage mechanic or owner-driver.

In order to meet special requirements for a Pressure Gauge to be used with our supercharger installations, we have available the gauge as illustrated. It incorporates both positive boost pressure readings and also negative pressures or vacuum readings. This gauge incorporates a damping device which ensures steady non-fluctuating readings to be obtained under all conditions.

The standard calibrations read 0-12 lbs. per square inch on both pressure scales. The diameter of the gauge is 2in. which matches existing instruments and is supplied with clamp fittings and connecting unions.



*Courtesy Al Moss  
May, 2008*

# performance plus . . . at all speeds . . .

## COMPARATIVE PERFORMANCE FIGURES

B.M.C. '950' A TYPE ENGINE  
(as fitted to Morris Minor 1000)

### POWER CURVES

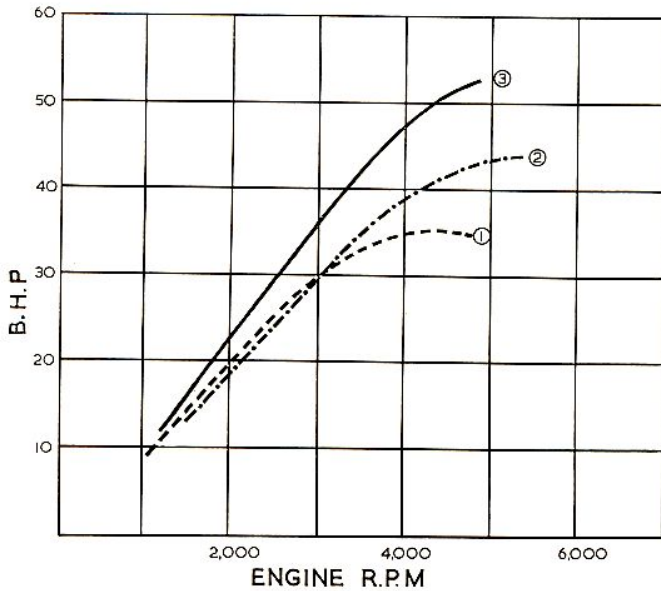

Curve (1) - - - - - Standard Engine  
Curve (2) - . . . . - Twin carbs and H.C. head  
Curve (3) - - - - - SHORROCK SUPERCHARGED

MORRIS MINOR 1000

### ACCELERATION THROUGH THE GEARS

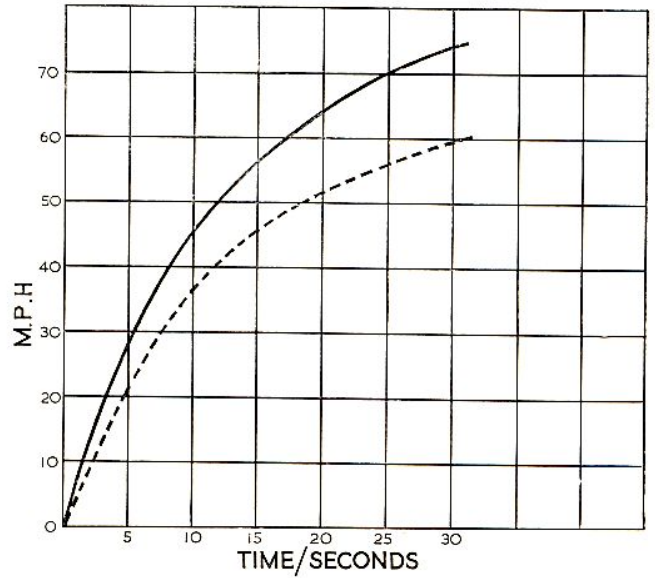

- - - - - Standard Engine  
- - - - - SHORROCK SUPERCHARGED

### MAXIMUM SPEEDS

Standard Engine 72.4 m.p.h.  
SHORROCK SUPERCHARGED 86 m.p.h.

FORD 105E ENGINE  
(as fitted to New Ford Anglia)

### POWER CURVES

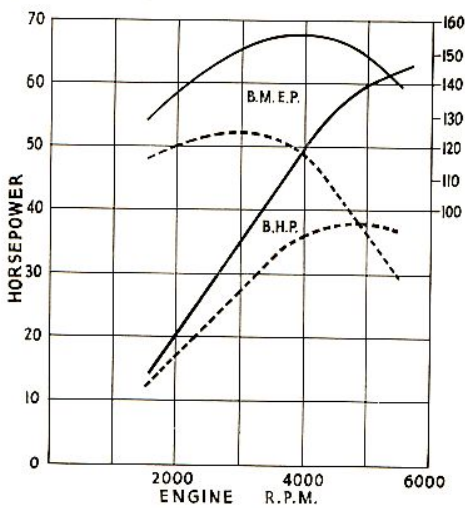

- - - - - Standard Engine  
- - - - - SHORROCK SUPERCHARGED

NEW FORD ANGLIA

### ACCELERATION THROUGH THE GEARS

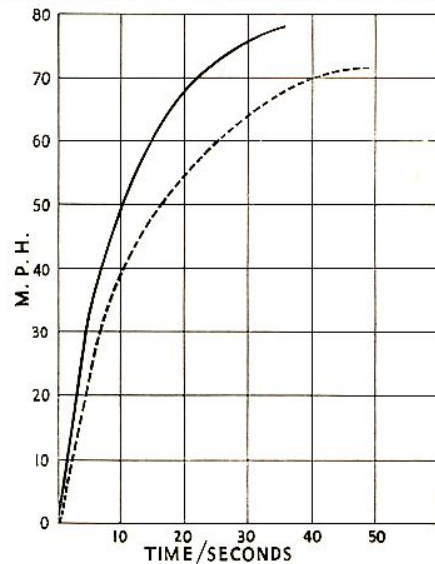

- - - - - Standard Engine  
- - - - - SHORROCK SUPERCHARGED

### MAXIMUM SPEEDS

Standard Engine 73.8 m.p.h.  
SHORROCK SUPERCHARGED 91.4 m.p.h.

Courtesy Al Moss  
May, 2008

. . . compact installation

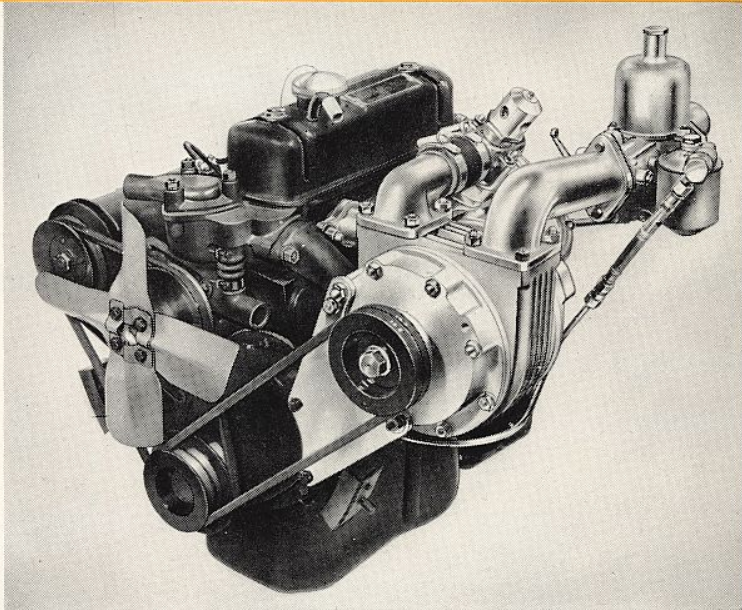

A Shorrock supercharger fitted to an exhibition AUSTIN "A" series engine shows off its neat appearance and how easily it can be fitted.

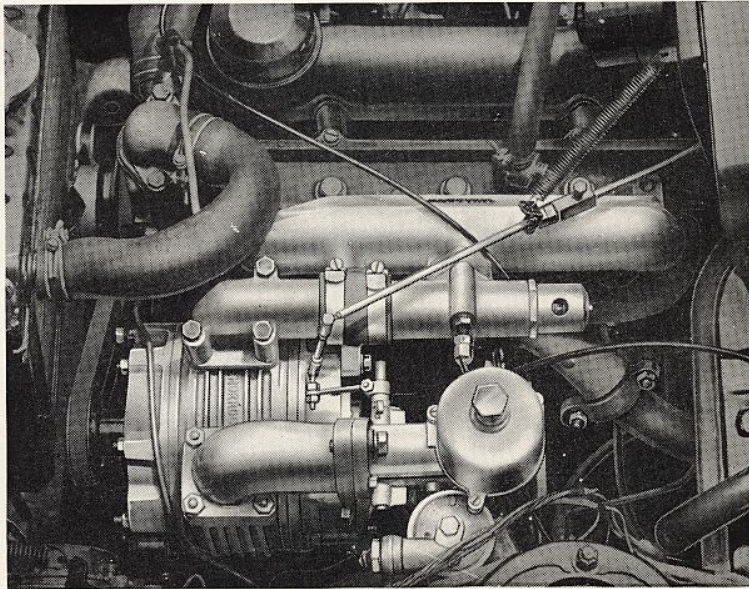

The Shorrock supercharger installation in the FORD ANGLIA gives a compact appearance and does not impair accessibility to any part of the engine.

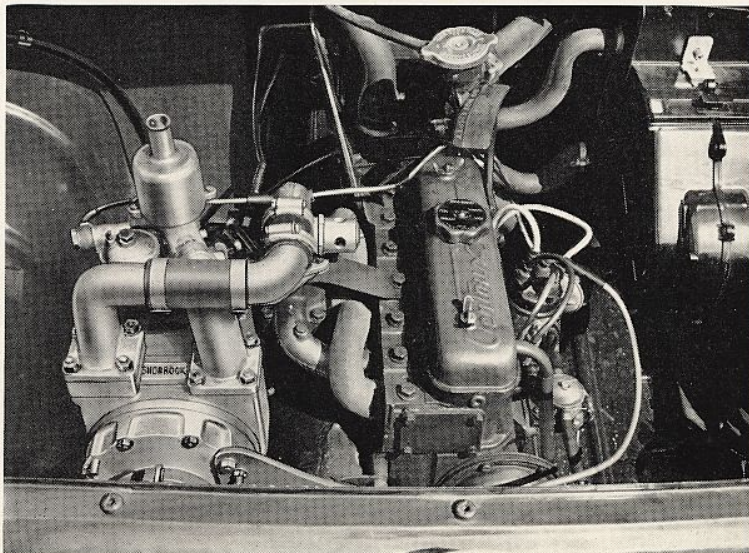

A neat looking appearance, accessibility to any part of the engine unimpaired that's the Shorrock supercharger fitted in the RENAULT DAUPHINE.

**SHORROCK**

## **SUPERCHARGER INSTALLATIONS**

A range of superchargers are available for most engines and we are always pleased to advise in the suitability of any supercharger within our range for a particular engine and to quote for supercharger and speed equipment work at these premises.

Detailed fitting instructions are supplied with every installation. Boost gauges and other accessories can be supplied as optional extras.

### **HIRE PURCHASE TERMS AVAILABLE**

#### **B.M.C. RANGE**

Superchargers for the B.M.C. range of vehicles are distributed throughout the world by The Donald Healey Motor Co. Ltd., The Cape, Warwick, England. *All orders and enquiries to be addressed to us direct until further notice.*

#### **FORD RANGE**

Superchargers for the Ford range of vehicles are distributed throughout the world by The Allard Motor Co. Ltd., Supercharger Division, 51 Upper Richmond Street, Putney, London, S.W.15, England.

#### **AUTOMOBILE ENGINEERS' REFERENCE BOOK**

Section 8 of this book which is entitled "Supercharging," was contributed by our Mr. Christopher Shorrock, Technical Director of the Company.

This section, fully illustrated, covers supercharging in all its aspects and is a mine of valuable information for all those interested in this subject. *Copies may be obtained from this company price 2/6d. postage paid in this country. remittance to be sent with order.*

#### **BOATS**

We also fit superchargers to power boats with the same fantastic results that we achieve on the modern car.

Write for details.

*Courtesy Al Moss  
May, 2008*

# SHORROCK GIVES YOU THAT **BIG** CAR PERFORMANCE

★ *Up to 50% more power*

★ *Improved engine flexibility*

★ *Quicker off the mark*

★ *Vastly improved acceleration*

★ *More hills in top*

★ *Less Gear Changing*

★ *Higher speeds*

★ *Faster Cruising*

THESE FEATURES OF SHORROCK SUPERCHARGING ARE ALL  
IMPORTANT FACTORS IN THESE DAYS OF CROWDED ROADS  
AND WITH THE INNOVATION OF NEW MOTORWAYS



*for performance*



DESIGN AND  
DEVELOPMENT OF  
COMPRESSORS,  
EXHAUSTERS,  
SUPERCHARGERS,  
I.C. ENGINES,  
AND  
EQUIPMENT FOR  
THE MOTOR  
INDUSTRY

*Courtesy Al Moss  
May, 2008*

**SHORROCK SUPERCHARGERS LTD.**

CHURCH HILL, WEDNESBURY, STAFFORDSHIRE, ENGLAND

Telephone : Wednesbury 1764/5

Telegrams : 'Shorrock, Wednesbury'

Member of the Owen Organisation



# GREETINGS



*Best Wishes for a Very Merry Christmas  
and a Prosperous New Year from  
SHORROCK SUPERCHARGERS LTD.*

*Eric Shorrock.*

**SHORROCK**

SHORROCK SUPERCHARGERS LIMITED.

'T.C.' MODEL M.G.

Comparative performance figures.

<u>M.P.H.</u>	<u>UN-SUPERCHARGED.</u>	<u>SUPERCHARGED.</u>
		<u>Acceleration in Top Gear.</u>
10 - 30	11.9 secs.	10.5 secs.
20 - 40	12.2 secs.	9.1 secs.
30 - 50	13.0 secs.	9.5 secs.
40 - 60	17.2 secs.	10.0 secs.
		<u>Acceleration in 3rd Gear.</u>
10 - 30.	7.9 secs.	7.0 secs.
20 - 40	8.0 secs.	6.8 secs.
30 - 50	9.3 secs.	6.5 secs.
40 - 60	11.6 secs.	7.0 secs.
		<u>Acceleration Through Gears.</u>
0 - 30.	5.8 secs.	4.2 secs.
0 - 40	9.0 secs.	6.5 secs.
0 - 50	13.9 secs.	9.7 secs.
0 - 60	21.1 secs.	13.0 secs.
Brake Horse Power.	54.0 at 5200 r.p.m.	69.0 at 5200 r.p.m.
Maximum Speed.	78.9 m.p.h.	95.m.p.h.
Overall Fuel Consumption.	33 m.p.g.	27.m.p.g.
Compression Ratio.	7.4-1.	7.4-1.
Fuel used in tests.	British Pool Petrol.	British Pool Petrol.
	70/72 Octane.	70/72 Octane.

The unsupercharged figures are from Road Test No 3/47 of the British journal 'The Motor'. The supercharged speed figures are the mean of several runs in opposite directions.

Courtesy Al Moss  
May, 2008

MG-TD MODEL  
COMPARATIVE PERFORMANCE FIGURES

<u>MPH</u>	<u>UNSUPERCHARGED</u>		<u>SUPERCHARGED</u>
		Acceleration in top gear	
10-30	11.5 secs		9.0 secs
20-40	11.8 secs		7.7 secs
30-50	12.7 secs		8.4 secs
40-60	17.3 secs		8.8 secs
		Acceleration in 3rd gear	
10-30	7.8 secs		6.8 secs
20-40	7.7 secs		6.0 secs
30-50	8.9 secs		6.0 secs
40-60	--		6.0 secs
		Acceleration thro' gears	
0-30	5.5 secs		4.2 secs
0-40	9.0 secs		6.5 secs
0-50	13.5 secs		9.4 secs
0-60	21.3 secs		11.7 secs
0-70	--		17.2 secs
Brake Horse Power	54 at 5200 RPM		69 at 52 RPM
Max. Speed	77.2 MPH		90 MPH
Overall Fuel Consumption	26.3 MPG		23 MPG
Fuel Used in Tests		British Pool Petrol	

The unsupercharged figures are from the ROAD TEST No. 1/50 of the "MOTOR".  
The supercharged speed figures are the mean of several runs in opposite directions.

LIST NO. 8184 - PRICE \$395.00,  
including F.E.T., f.o.b. Warsaw,  
Indiana.

SHORROCK SUPERCHARGERS LTD.  
1250 C.C. MG ENGINE (TYPE-XPAG)  
COMPARATIVE PERFORMANCE CURVES

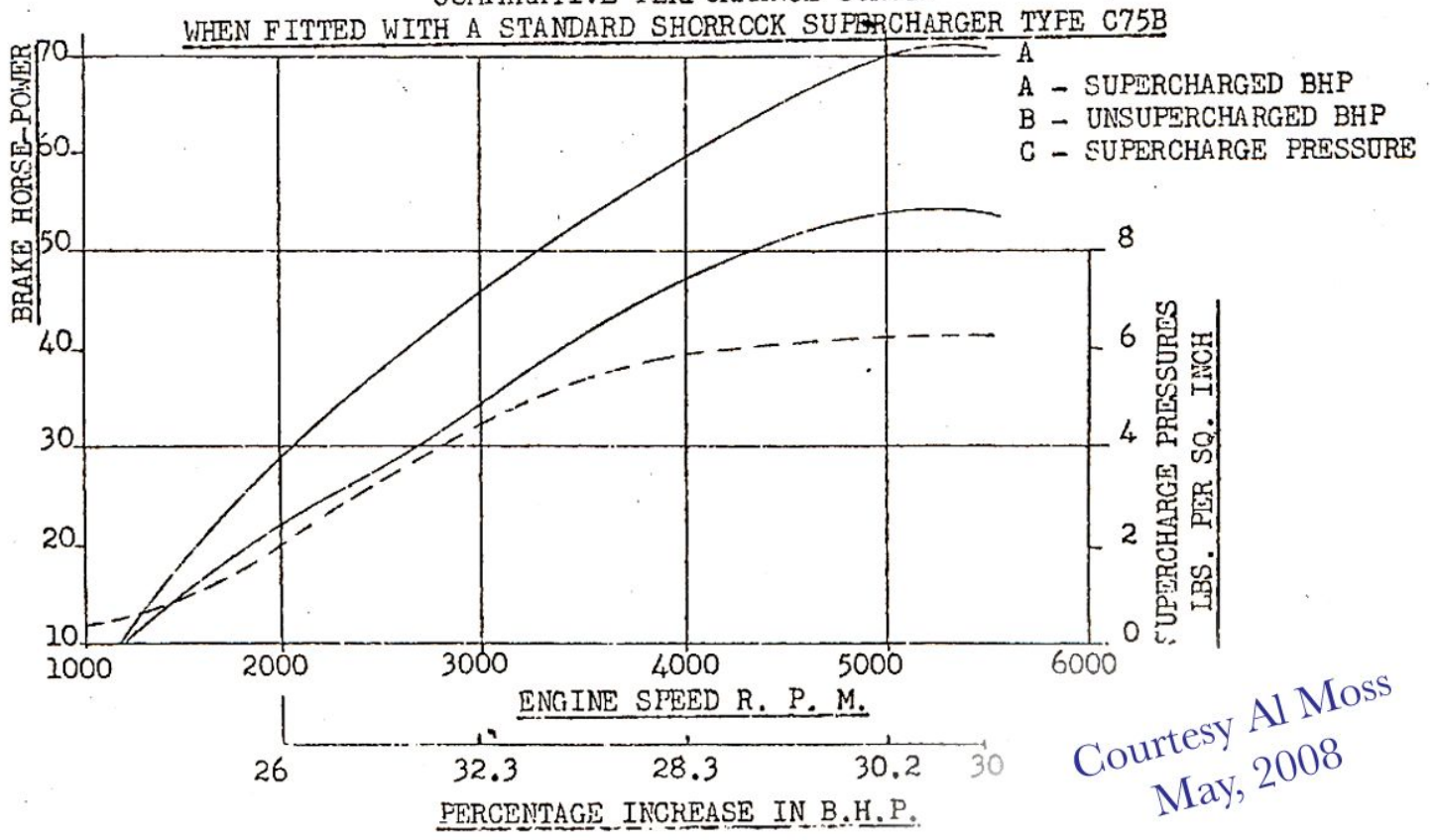

*Courtesy Al Moss  
May, 2008*

# **SHORROCK SUPERCHARGER**

(FITTED WITH S.U. CARBURETTOR)

for

**M.G.**

(SERIES TD)

**FITTING & SERVICING  
INSTRUCTIONS**

*Courtesy Al Moss  
May, 2008*

---

**SHORROCK SUPERCHARGERS LTD., COVENTRY, ENGLAND**

---

# FITTING INSTRUCTIONS

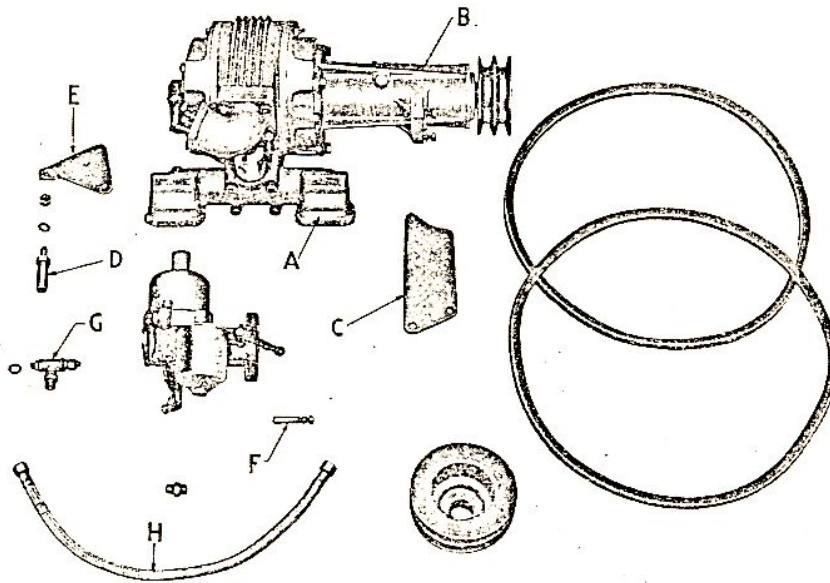

## 1. INTRODUCTION

The design of the installation set is such that the work may be confidently carried out by any competent garage mechanic or owner driver, and necessitates no modifications to the engine or chassis. Fitting is simplified by reading these instructions through before starting work.

The supercharger is mounted on the manifold side of the engine and is driven by twin vee-belts from the front end of the crankshaft.

## 2. PRELIMINARY

Drain radiator.

Disconnect carburettor controls, remove air cleaner, carburettor and inlet manifold. The air cleaner is not replaced as its capacity is not sufficient for the supercharged engine.

Remove crankshaft pulley.

Remove radiator stay tube on manifold side of engine. This is not replaced.

## 3. PULLEYS AND BELTS

Fit new three-groove pulley, placing the existing belt and the two new belts over the pulley before fitting. Care should be exercised when attaching the pulley as, being made of cast iron, undue force could cause damage.

*Moss Motors*  
1015 DeSoto Avenue  
GOLTA, CALIFORNIA

*Courtesy Al Moss*  
*May, 2008*

#### 4. MOUNTING OF SUPERCHARGER

The supercharger, complete with new inlet Manifold (A) and drive housing (B) may now be fitted, both inlet and exhaust manifolds being clamped by the existing clamps. The front plate (C) is fitted between the lug on the underside of the drive housing and the two bolts holding the square flange of the water pipe to the cylinder head. The cylinder head nut behind the rear inlet port is removed and replaced by the barrel nut (D), the back stay plate (E) is bolted to this and two of the supercharger end-plate studs.

The dynamo drive belt is refitted, and the two supercharger drive belts are then fitted over the supercharger pulley; it may be necessary to cut away a small section of the radiator header tank support web to accomplish this.

#### 5. CARBURATION

The carburettor is next fitted to the supercharger and the existing jet control wire connected as on the original. The petrol pipe is now connected by linking the two existing pipes with the double-ended union supplied. To connect the throttle control, remove the existing control rod from the lever and fit the extension piece (F). The original control rod is now replaced, and connected to the throttle arm on the carburettor, as on the original.

#### 6. LUBRICATION

Supercharger lubrication is obtained from the engine oil supply by replacing the rocker oil feed banjo on the cylinder head with the new union and tee-piece (G) supplied. The banjo on the oil feed pipe is removed and replaced with the union nut and nipple supplied attached to tee-piece. This pipe is connected to one branch of the tee-piece, and the other branch is connected to the supercharger by the flexible oil pipe (H).

The drive housing is now partially filled with a good grade of 30 viscosity engine oil through the plug provided at the top of the housing, the level being governed by the plug on the underside of the housing.

For servicing and fitting of spare pin (if necessary) see under Servicing, paragraph 10 (Lubrication), on back page.

#### 7. RADIATOR

Refill radiator.

#### 8. TUNING

It now remains to test the car on the road in order to obtain the correct carburettor and ignition settings—but read to the end of these instructions first and see your car instruction book for tuning the S.U. carburettor!

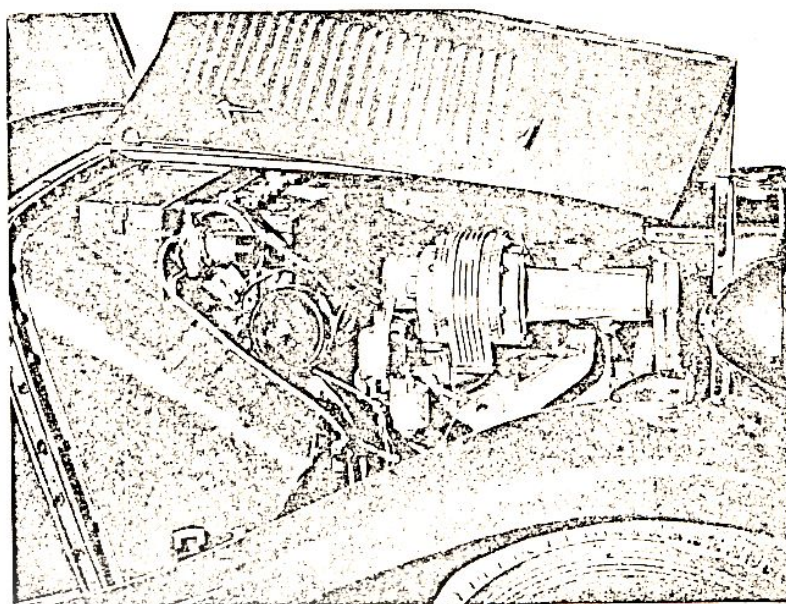

*Courtesy Al Moss  
May, 2008*

# SERVICING INSTRUCTIONS

## 9. INTRODUCTION

The Shorrock supercharger is a precision mechanism, which is fully tested before despatch. Like any other machine, however, it requires running-in, and should be driven gently for the first 250 miles. During this period the maximum road speed in top and third gears should not exceed 45 m.p.h. and 30 m.p.h. respectively. Properly treated, it will give many thousands of trouble-free miles.

Dismantling or major overhauls should only be undertaken by your Dealer or his Distributor.

## 10. LUBRICATION

It is essential that the engine oil be kept **clean and free from sludge**. Dirty, unsuitable or graphited oil will clog the lubricating passages and eventually lead to serious damage.

This supercharger is despatched with an "E" pin in its lubricator. This should be satisfactory for initial running, and quite likely permanently. As a guide, there should be a slight amount of **smoke** from the exhaust on starting up from cold, which should clear after a few minutes running. Should, however, signs of pronounced over-oiling arise (for instance, clouds of exhaust smoke), then the lubricator pin should be replaced by the larger one "C" supplied in the plastic capsule bolted to the supercharger. If this spare pin is used, be sure to tighten down firmly the supercharger nuts after detaching the capsule, **and**, after fitting the new pin, check that the supercharger is getting a supply of oil!

Every 1,000 miles the lubricator pin should be removed from the supercharger, and the pin wiped with a soft rag: **on no account should abrasives be used.**

To remove and replace the lubricator pin, proceed as follows:—

Models with external lubricator (of brass)—  
unscrew the plug at the end of the lubricator furthest from the shaft, when the plug, spring and pin will come out together.

Models with lubricator inside the drive shaft—  
unscrew the pipe union at the end of the supercharger, when the spring will push out the pin.

To re-assemble, assemble pin, spring and plug together, insert and screw down plug firmly.

To re-assemble, insert spring first, then pin, then screw down pipe union firmly.

It must be remembered that the supercharger drive housing is **not** connected to the engine oil supply. The level should be checked every 1,000 miles.

## II. CONCLUSION

Confident of the experience and care built into the Shorrock supercharger, we wish you many thousand miles of enjoyable motoring from the much improved performance of your M.G. (TD)!

Keep these instructions for reference. In any correspondence quote supercharger specification and serial number.

**SHORROCK SUPERCHARGERS LTD., COVENTRY, ENGLAND**

SP2

S/52/1000

*Moss Motors Ltd.*

5775 DAWSON AVE

SCOTT'S BLVD

*Courtesy Al Moss  
May, 2008*

'SUPERCHARGING M.G. "X.P.A.G." POWER UNITED'  
THE SHORROCK INSTALLATION.

By W.E. Blower.  
(With acknowledgments to Shorrock Superchargers Ltd.)

The Shorrock Supercharger is the outcome of many years of experience in the design of high-efficiency compressors, resulting in the production of a supercharger with remarkably high adiabatical efficiency and low power absorption, operating with complete absence of mechanical noise.

It is a positive displacement eccentricdrum-type compressor, employing four vanes. The vanes are mounted radially to the compressor casing, each vane being carried by two ball journals mounted on a shaft of ample dimensions, concentric with the outer casing. The vanes are impelled by the internal rotor, which is mounted eccentrically to the outer casing, and through which the vanes pass. The angular motion of the vanes relative to the rotor is accommodated by specially designed trunnions. This construction makes practical the very fine clearances necessary for high efficiencies, since the vanes being mounted radially to the casing, and anchored by the vane shaft, cannot come into contact with the casing, yet can be run at very high speeds.

The four vanes passing through the rotor, and having very fine clearances between their extremities and the casing and end plates, virtually subdivide the crescent-shaped chamber into four separate chambers. The inlet port of the supercharger is so positioned that as one of the chambers receives its full volume of air the adjacent chamber (on the inlet side of the unit) is increasing in volume and creating a vacuum at the inlet port. Immediately the vanes have reached the position where the chamber between them contains its maximum volume, the volume between the vanes diminishes as the space between the rotor and the casing becomes less, thus compressing the charge within the supercharger itself, before releasing it through the outlet port into the engine manifold.

The rotor itself is carried on its own bearings mounted in the supercharger end plates. The rear end of the rotor is carried by a large ball race whilst the drive end is carried by a substantial roller journal mounted on the drive shaft. The drive shaft is integral with the rotor end plate, the outer race of the roller journal being mounted in the supercharger front end plate.

Particular attention has been given to the lubrication which is fully automatic. Due to the special design features only a very small quantity of lubricant is required to enable the supercharger to function with complete reliability.

The supercharger is mounted on the manifold side of the engine and driven by twin vee-belts from the front end of the crankshaft.

The installation design is such that the fitting may confidently be carried out by any competent garage mechanic or ownerdriver.

Continued.....

Courtesy Al Moss  
May, 2008

SOLELY BY  
GOLETA, CALIFORNIA



Continued...

Open the drain taps in the bottom of the radiator and right-hand side of the cylinder block, and whilst the cooling system is draining remove the bonnet complete. Remove the carburettor controls, air cleaner and branch pipe, carburettor(s) and inlet manifold. As the capacity of the air cleaner is not sufficient for the supercharged engine, it is not replaced. Remove the fan belt after slackening the dynamo mounting and adjusting bolts. Remove the starting handle dog nut and remove the pulley from the front end of the crankshaft.

With the Midgets, Series "TB" and "TC" it will be necessary to remove the front engine mounting bolts and raise slightly the front of the engine before the pulley can be withdrawn. Remove the bolts securing the radiator right-hand stay tube to the radiator and engine bulkhead and remove the tube. This is not replaced. Fit the three-grooved pulley supplied with the installation kit, placing the existing belt and the two new belts over the pulley before fitting. As the pulley is made from cast iron, extreme care should be exercised when fitting as undue force may cause considerable damage. Replace the starting handle dog nut.

Fit the supercharger complete with the special inlet manifold provided, and drive housing, both the inlet and exhaust manifolds being clamped by . The front plate is fitted between the lug on the under side of the drive housing and the two bolts holding the square flange of the water pipe on the cylinder head.

Remove the cylinder head nut behind the rear inlet port and replace with the barrel nut the back stay plate being bolted to this and two of the supercharger end plate studs. Fit the dynamo drive belt and the twin supercharger drive belts over the supercharger pulley. It may be found necessary to cut away a small section of the radiator header tank support web to accomplish this. Fit the carburettor to the flange on the supercharger and reconnect the existing jet control wire in its original position. Connect the petrol pipe by linking the two existing pipes with the double-ended union supplied.

To connect the throttle control, remove the existing control rod from the lever and fit the extension piece. Replace the original control rod and connect to the throttle arm on the carburettor, as originally.

#### LUBRICATION.

The supercharger librication is obtained from the engine oil supply by replacing the rocker oil feed banjo on the cylinder head with the union and tee piece. Remove the banjo on the oil feed pipe and replace with the union nut and nipple supplied attached to the tee piece.

Connect the oil feed pipe to the overhead valve gear to one branch of the tee piece, the other branch being connected to the supercharger by the flexible oil pipe supplied. Remove the oil filler plug from the top of the drive housing and partially fill the drive housing with a recognised brand of S.A. . 30 engine oil. The level of oil is governed by the plug on the under side of the housing.

Continued.....

Courtesy Al Moss  
May, 2008

1500 AVENUE  
GOLETA, CALIFORNIA

Continued..2....

Adjust the dynamo and securely tighten it in position, close the drain taps and refill the system with water. Refill the bonnet and test the car on the road to obtain the correct carburettor and ignition settings.

#### RUNNING IN.

The supercharger is a precision mechanism and although fully tested before dispatch requires running in, and it should be driven gently for the first 250 miles. During the running-in period the maximum road speed in top and third gears should not exceed 45 m.p.h. and 30 m.p.h. respectively. Dismantling and major overhauls should only be undertaken by authorised distributors or dealers, but it is preferable for the installation to be removed as a complete unit and returned to Shorrock Superchargers Ltd. Church Hill, Wednesbury.

The lubricating oil must be kept clean and free from sludge as dirty, unsuitable or graphited oil will clog the lubricating passage, eventually leading to serious damage.

The supercharger when dispatched by the manufacturer, is fitted with a .309 in. diameter pin in its lubricator, which should prove satisfactory for initial and permanent running. When starting up from cold there will be a slight amount of smoke from the exhaust, but this is quite normal and should clear after a few minutes' running.

An oversized pin, .310 in. in diameter, is supplied in a plastic capsule bolted to the supercharger, and should signs of pronounced oiling arise this pin should be fitted in place of the standard pin. If the larger diameter pin is fitted be sure to tighten down firmly the supercharger nuts after detaching the capsule, and after fitting the new pin check that the supercharger is receiving an adequate supply of oil. Every 1,000 miles remove the lubricator pin and wipe with a soft rag. ABRASIVES MUST NOT BE USED.

To remove the lubricator pin proceed as follows: (Supercharger with external brass lubricator.) Unscrew the plug at the end of the lubricator farthest from the shaft, when the plug spring and pin will come out together. To reassemble, assemble pin, spring and plug together, insert and screw down plug firmly.

For superchargers with the lubricator inside the drive shaft unscrew the pipe union at the end of the supercharger, when the spring will push out the pin. To reassemble, insert the spring first, then the pin, and screw up the pipe union firmly.

As the supercharger drive housing is not connected to the main engine oil supply the level should be checked every 1,000 miles.

The early type superchargers, with the separate oil tank fitted to the engine bulkhead, were fitted with a standard oil metering pin .304 in. in diameter, with an alternative pin .306 in. in diameter. This type of supercharger can, however, be very easily modified to the later type now available.

Continued.....

Courtesy Al Moss  
May, 2008

Motor, Ltd.  
AVENUE  
CALIFORNIA

System of Lubrication:

The system of lubrication for the Shorrock Supercharger has been designed to give trouble free service. It is very simple in operation but it is thought that some explanation would perhaps be of help and guidance to the owner of a Shorrock supercharged car or vehicle.

Oil is fed, under normal engine oil pressure by means of flexible pipes from the pressure gauge or oil warning light tapping in the crankcase of the engine, to the lubricator, which is positioned, in the centre of the rear end plate of the supercharger.

There are two types of lubricator, both of which are similar in detail, the only difference being, that whereas one is integral with the supercharger, the other is a separate small casting and is bolted to it.

The lubricator consists of a reamed 5/16" bore .3125. Into this bore is fitted a finely machined restrictor, or metering pin. The size of this pin is dependant upon the engine oil pressure and the viscosity of the oil used, but a range of pins is made to cover nearly all eventualities. The largest of these pins, which are lettered alphabetically is the "A" .311. These decrease in size a  $\frac{1}{2}$  than .00005 at a time, thus a "B" pin will be .3105 and a "C" pin .3100 and so on.

When a supercharger installation is despatched from Our Works it is fitted with a metering pin which is the correct size for the engine to which it is to be installed. To take care of any difference which might occur between one engine, of the same make, and another, a second pin is supplied one size above the one which is fitted, this is usually bolted to the casing of the supercharger in a plastic capsule.

It will no doubt be realised that if for some reason the engine oil is changed for one higher or lower viscosity some adjustment may have to be made, by changing the metering pin to compensate for this. And again if a very thin additive is used, thus bringing down the oil viscosity, the same will apply. It has been found that the correct rate of oiling for the supercharger is approximately 1 pint per 1,000 miles. As this is completely lost to the engine, topping up of the sump should be slightly more frequent.

It should be pointed out that although the oil used by the supercharger is lost to the engine, it has some compensation in the fact that it supplies the engine with upper cylinder lubricant nearly all the time. More especially when the engine is started from cold, at this time, the presence of oil in the fuel will be visible from the exhaust smoke.

The method of removing and replacing metering pin is described in the installation and maintenance instructions supplied with each supercharger installation set.

Courtesy Al Moss  
May, 2008

# Instructions for dismantling & reassembling the Shorrock Supercharger

## IMPORTANT

With proper care and servicing in accordance with the instructions sent out with every unit, the Shorrock Supercharger should only require stripping and overhaul after very long periods of running. When complete overhaul is considered necessary, we strongly recommend that the unit be returned to our Distributor or Dealer, who has the experienced personnel and the necessary tools to undertake the work. If this is impossible or if the owner wishes to do the work himself the procedure given herewith should be adopted. At the outset it cannot be too strongly emphasised that the Shorrock Supercharger is a precision mechanism, built to fine limits for efficiency, and undue force may easily cause damage. Throughout the work, cleanliness is of paramount importance.

## PRELIMINARY

Remove Supercharger from engine and remove all manifolds, pulleys, pipes and brackets. Remove outrigger housing and shaft, where fitted, by undoing the three nuts securing the housing to the drive end plate. It is convenient to remove the lubricator body from the rear end plate, thus giving a flat surface on which to rest the Supercharger. The lubricator body is removed by undoing the four countersunk head screws holding it to the rear endplate.

## IMPORTANT

Before commencing reassembly all parts should be washed in clean petrol (not paraffin) and all traces of grit and dirt removed. The countersunk holes in the two locking plates and the rotor drive plate must be cleaned up with a countersink bit to remove burrs caused by the original locking of the screws.

After cleaning, all ball races, trunnions, vanes, vane shaft and rotor drive plate, must be well oiled with clean engine oil.

All tools and the bench used for reassembly must be scrupulously clean to avoid any dust or dirt entering the supercharger—Remember it is a precision mechanism assembled to fine limits.

When tightening a ring of nuts or screws be sure to tighten evenly to avoid distortion.

After overhaul, particularly if new parts have been fitted, the supercharger should be run-in again in accordance with the servicing instructions.

*Courtesy Al Moss  
May, 2008*

When ordering new parts, specification number and serial number of supercharger must in all cases be quoted - **this is essential.**

A comprehensive supply of parts is

# Instructions for dismantling & reassembling the Shorrock Supercharger

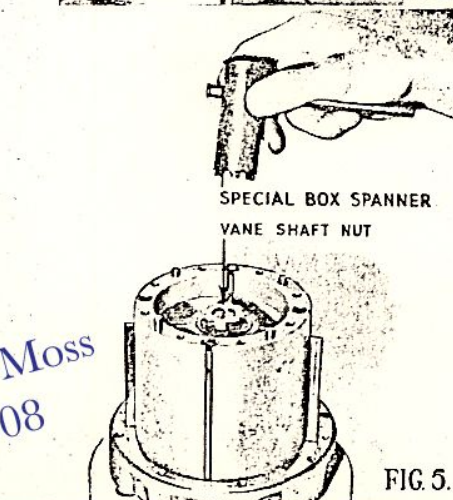
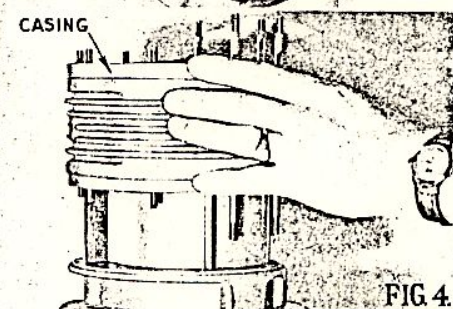
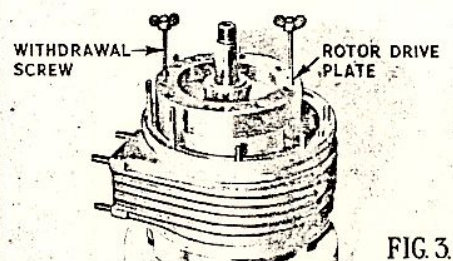
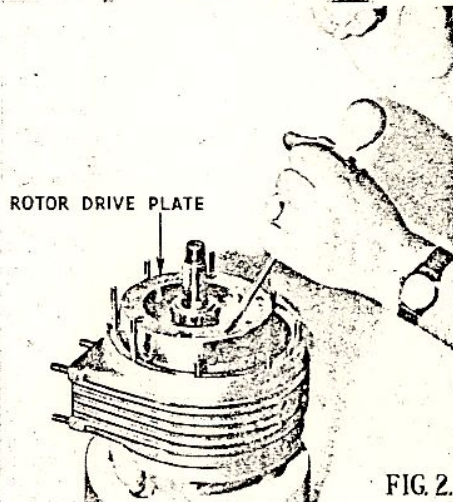
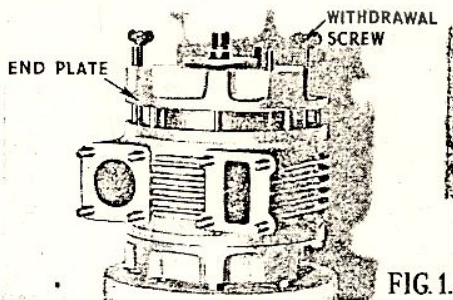

## DISMANTLING

### 1. Removal of Drive End Plate.

Undo ring of nuts securing endplate to casing. Remove end plate using two  $\frac{3}{16}$ " Whitworth withdrawal screws (Fig. 1), in tapped holes provided. Take care to withdraw end plate squarely.

### 2. Removal of Rotor Drive Plate

Clear centre-punch depressions in heads of countersunk screws (Fig. 2), securing rotor drive plate to rotor. Remove ring of screws.

### 3. Remove Rotor Drive Plate, using two $\frac{3}{16}$ " Whitworth withdrawal screws (Fig. 3), in tapped holes provided. Take care to withdraw plate squarely.

### 4. Removal of Casing.

Undo ring of nuts securing casing to rear endplate. The casing must be taken off squarely (Fig. 4), to avoid damage to vanes and casing bore.

A fairly comprehensive examination can be made at this stage, but should further dismantling prove necessary, proceed as follows:—

### 5. Remove Vane Shaft Locknut

The nut is locked by a split pin or tab washer. Remove nut, for which special box spanners are available.

Courtesy Al Moss  
May, 2008

Moss Motors Ltd.  
5710 DAYTON AVENUE  
GOLTA, CALIFORNIA

# Instructions for dismantling & reassembling the Shorrock Supercharger

## 6. Removal of Vane Assembly.

- A special mandrel to the dimensions given further on is essential. Place mandrel against end of vane shaft, invert (Fig. 6) and tap end of mandrel on bench when the vane assembly will slide onto the mandrel on which it should be retained until reassembly, any shims being carefully kept until reassembly. The trunnions will come out with the vane assembly and if removed from the vanes (Fig. 7), should be identified each with its own vane so that on reassembly each trunnion may be replaced on its original vane with all relative bearing surfaces re-positioned as prior to dismantling. Under no circumstances should the vane assembly be dismantled or removed from the mandrel. No attempt should be made to replace one or more vanes or ballraces, as owing to the accuracy and balance required we only supply a new vane assembly complete and do not supply separate parts for this assembly.

## 7. Removal of Rotor.

Clear the centre-punch depressions in the heads of the countersunk screws securing the locking plate at the bottom of the rotor and remove screws (Fig. 8) and plate. Withdraw rotor complete with ball race (Fig. 9) from rear endplate.

## 8. Removal of Rotor Ball Race.

Remove countersunk head screws, first clearing screws, and remove locking plate. Remove ball race.

The vaneshaft cannot be separated from the rear end plate. They are locked together for accuracy of alignment and are supplied as a complete assembly, (Fig. 10).

The Supercharger is now completely dismantled.

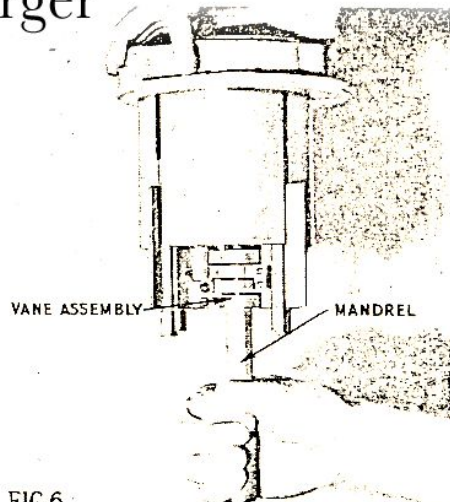

FIG. 6.

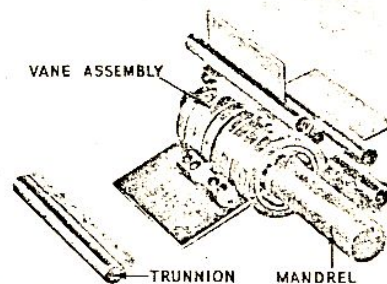

FIG. 7.

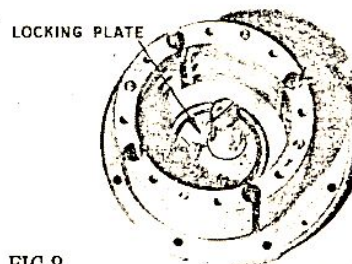

FIG. 8.

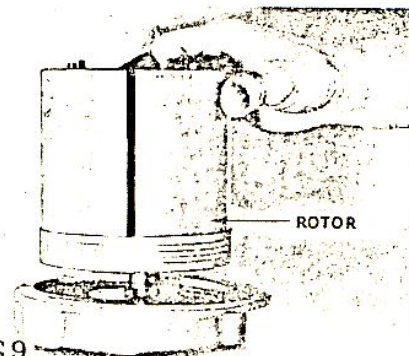
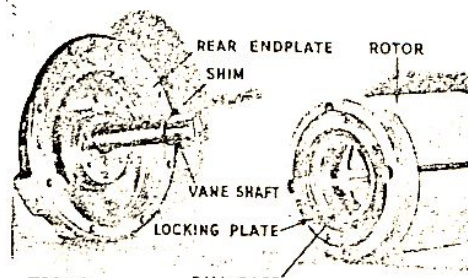
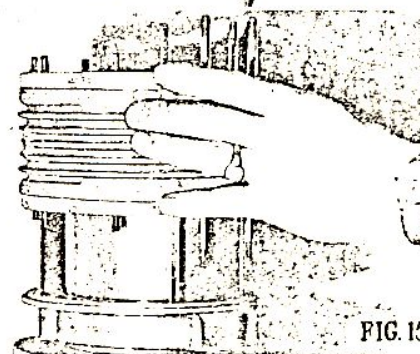
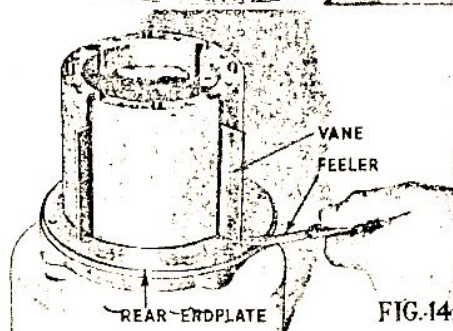
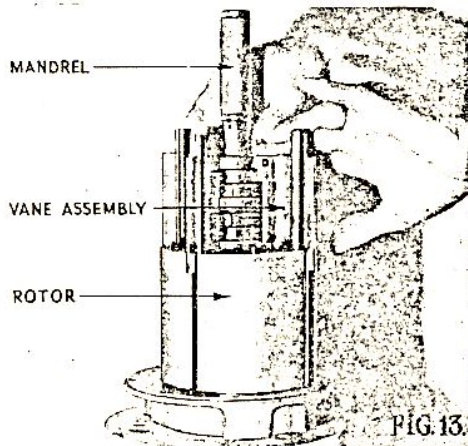
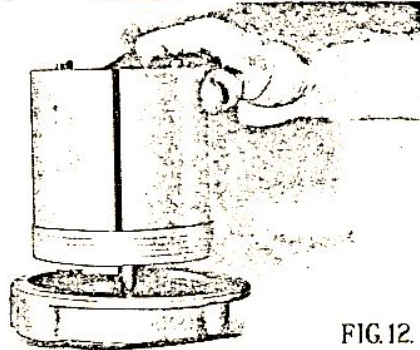
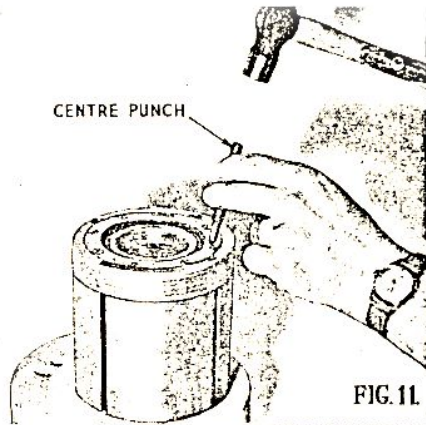

FIG. 9.



# Instructions for dismantling & reassembling the Shorrock Supercharger



## REASSEMBLING

1. Assemble Rotor Ball Race and Rotor Locking Plate.

Be sure to lock all countersunk screws with a centre punch (Fig. 11).

2. Replace Rotor and Locking Plate, locking all countersunk screws (Fig. 12).

3. Replace Vane Assembly & Trunnions, ensuring that the original shims are first placed on the vane shaft (Fig. 13). Replace vane shaft nut and tighten, using special box spanner. Replace split pin or lock tabwasher.

4. Check Vane Clearance between vanes and rear end plate (Fig. 14). The clearance must be between .004" and .006". This may be adjusted by the use of extra shims.

5. Replace Casing.

Care must be taken to ensure that the casing is replaced the correct way round for the rotation required (Fig. 16).

Ensure that the dowel in the casing registers in the end plate, care being taken to replace the casing squarely (Fig. 15), to avoid damage to vanes and casing bore.

Courtesy Al Moss  
May, 2008

# Instructoins for dismantling & reassembling the Shorrock Supercharger

## 6. Reversal of Rotatior.

Should it be desired to change the Supercharger rotation from clockwise to anti-clockwise rotation or vice-versa looking at the drive end, (Fig. 16) gives the positions of inlet and outlet ports for the two rotations on various casings.

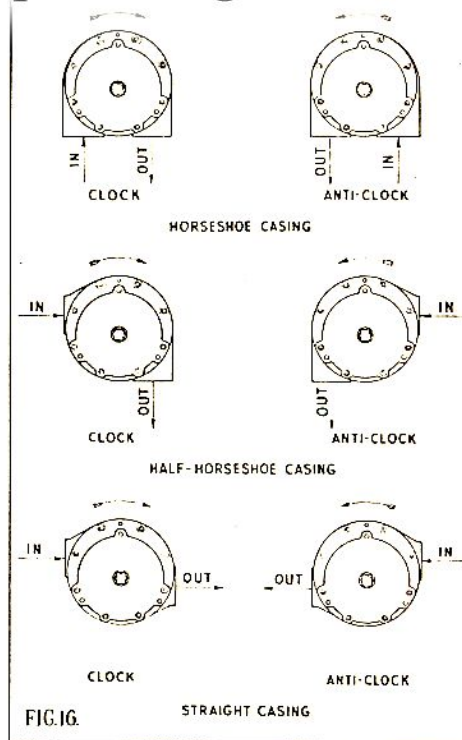

## 7. Replace Rotor Drive Plate.

This must be replaced squarely (Fig. 17) and register correctly on the four dowels in the rotor. Tighten the ring of counter-sunk head screws evenly and lock (Fig. 11).

FIG. 17.

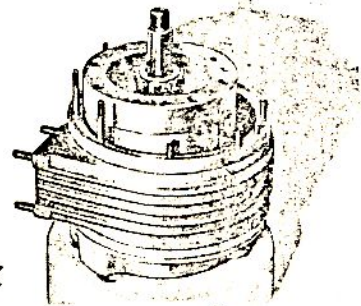

## 8. Replace Drive End Plate (Fig. 18).

Ensure that the casing dowel registers correctly, tighten ring of nuts evenly and replace drive shaft nut and washer.

FIG. 18.

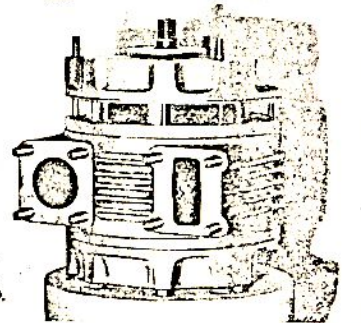

## 9. Turn the Drive Shaft gently by hand or with a suitable spanner (Fig. 19).

The Supercharger should turn easily. If it feels stiff or any scraping is audible remove end plate and ascertain cause.

On no account should the Supercharger be run until it revolves freely.

FIG. 19.

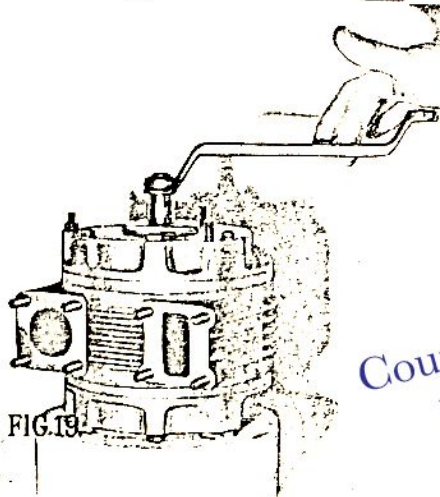

Courtesy Al Moss  
May, 2008



S MOTOR & LTD,  
 WILES & COPT. THE  
 STOCK OF SUPERCHARGERS,

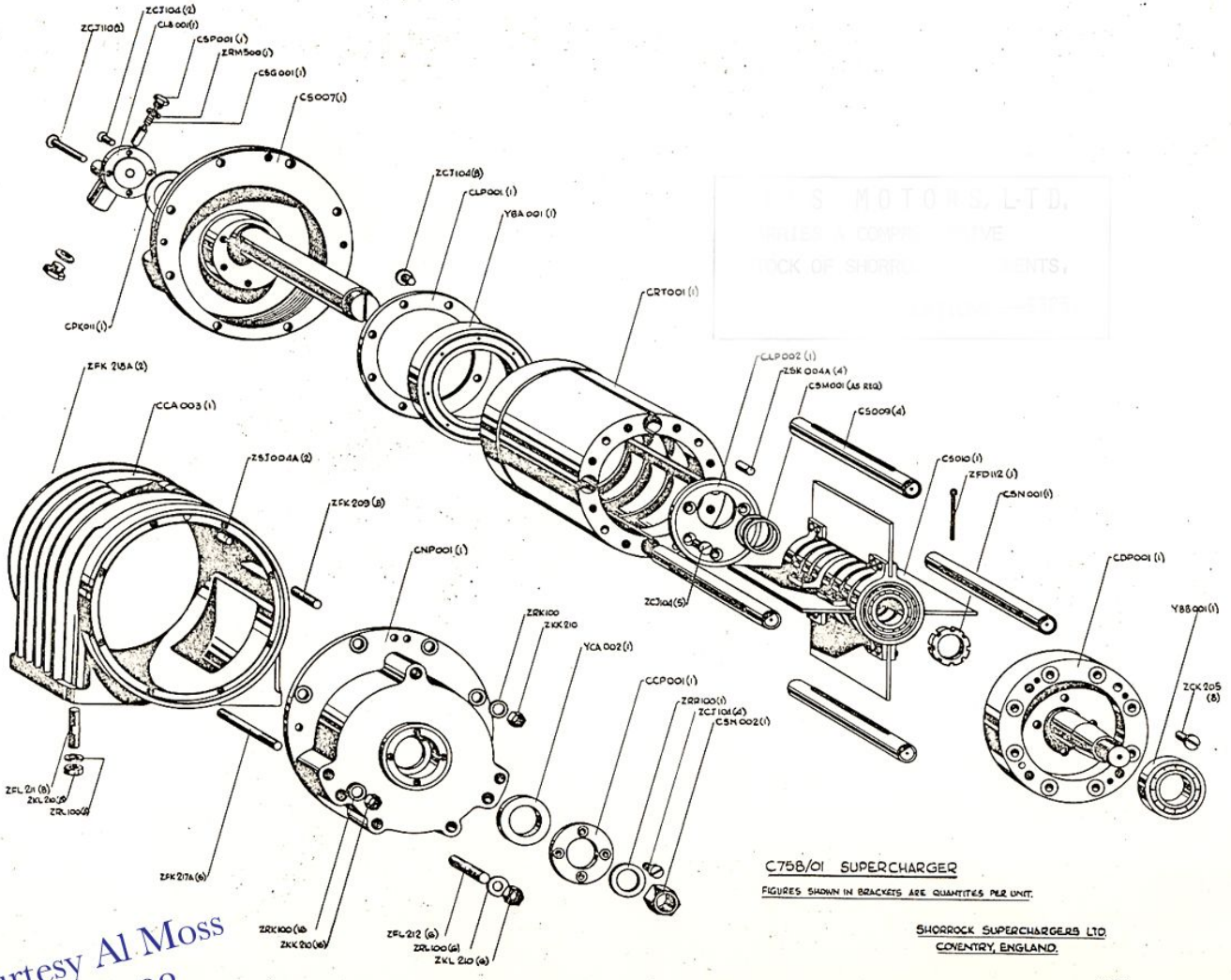

C75B/01 SUPERCHARGER

FIGURES SHOWN IN BRACKETS ARE QUANTITIES PER UNIT.

SHORROCK SUPERCHARGERS LTD  
COVENTRY, ENGLAND.

7-11-52

Courtesy Al Moss  
 May, 2008

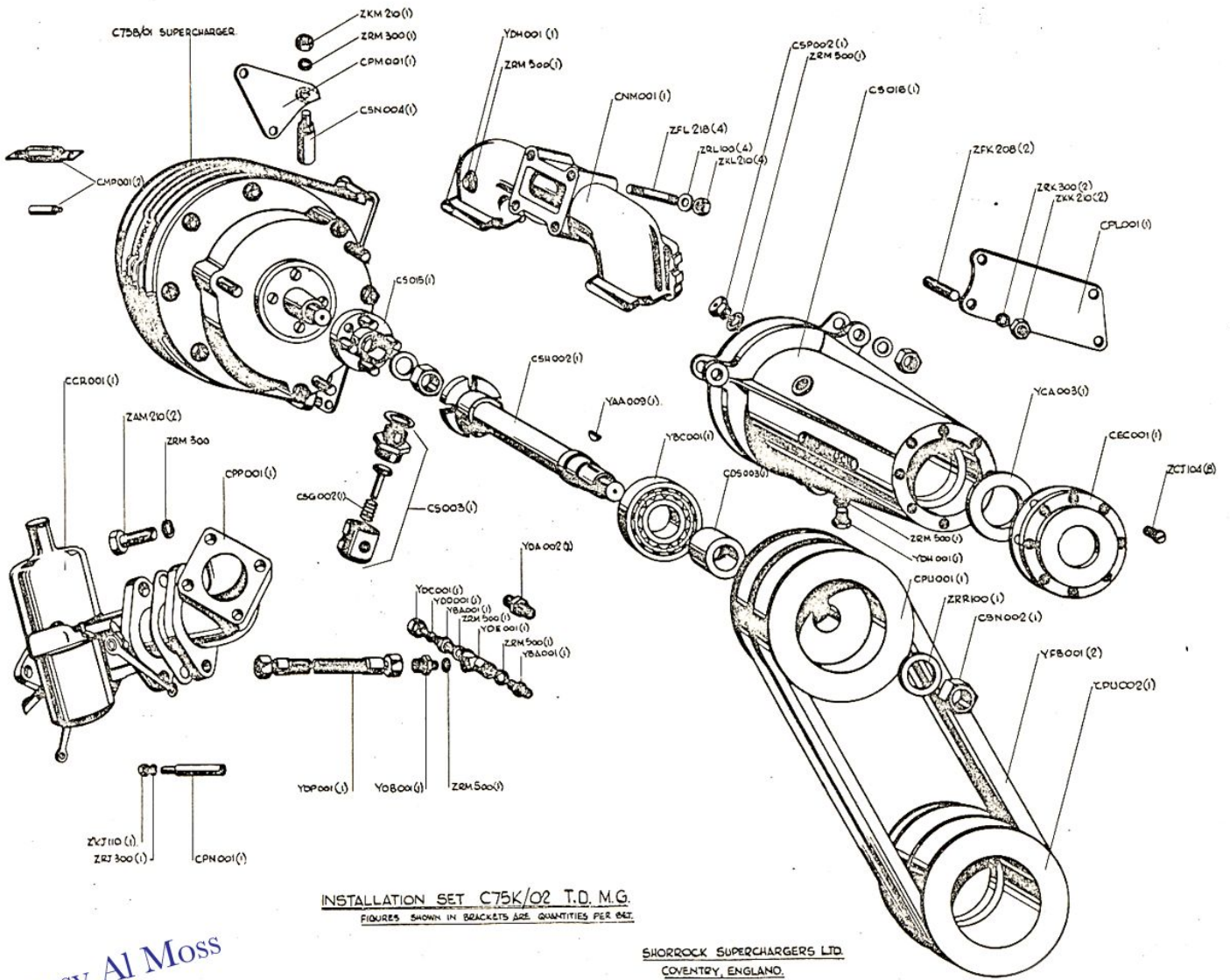

INSTALLATION SET C75K/O2 T.D.M.G.  
 FIGURES SHOWN IN BRACKETS ARE QUANTITIES PER SET.

SHORROCK SUPERCHARGERS LTD.  
 COVENTRY, ENGLAND.

Courtesy Al Moss  
 May, 2008

Moss Motors Ltd.  
 578 DAWSON AVENUE  
 GOLETA, CALIFORNIA

# SHORROCK

## Supercharging

### for faster Motoring

Courtesy Al Moss  
May, 2008

This photograph shows the neat and compact installation of the Shorrock Supercharger on the M.G. car.

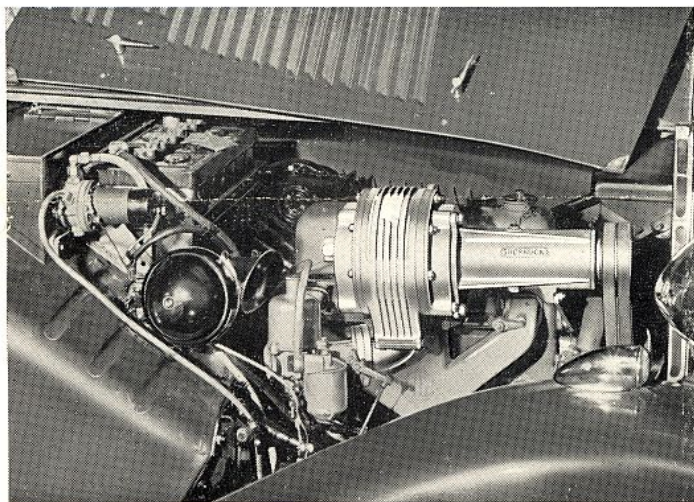

## IMPROVED PERFORMANCE

This diagram illustrates the relative power of the M.G. supercharged and unsupercharged. The car fitted with the supercharger has more power available enabling hills to be climbed faster, giving greater acceleration and a better overall performance.



## You benefit by

### Improved flexibility

which means less gear changing at all times. Many more hills can be taken "in top," and all at higher speeds if desired.

### Snappier acceleration

The substantially increased power gives rapid off-the-mark acceleration to reach high cruising speeds with the minimum of delay.

### Higher average cruising speed

Without the necessity of raising the car's normal top speed, the much increased power will raise considerably the M.G.'s. average cruising speed.

*There are also Shorrock Supercharger installations for other cars.*

*Distributed in the United States of America by*

**Autocessories, Ltd.**  
WARSAW, INDIANA, U.S.A.

PRINTED IN ENGLAND

SP5/3000/9/52

**SHORROCK SUPERCHARGERS LTD COVENTRY ENGLAND**

# SHORROCK

Courtesy Al Moss  
May, 2008



## SUPERCHARGERS for

### *Performance Plus at All Speeds*

POWER INCREASE  
AT ALL SPEEDS

HIGHER MAXIMUM  
SPEED

GREATER  
ACCELERATION

30% MORE POWER

COMPLETE  
INSTALLATION  
READY TO FIT

EASILY INSTALLED

The installation of the Shorrock Supercharger on the post-war models of the M.G. range further enlivens the high performance which has come to be expected from these well-known cars.

Providing substantially more power—up to 30%—for the M.G., the Shorrock Supercharger gives greatly improved acceleration, engine flexibility, hill climbing and top speed for an increase in fuel consumption of approximately 10%. All this is achieved silently and dependably, and without impairing the reliability of the car in any way. Exhaustive tests over many thousands of miles all over the world have conclusively shown that this enhanced performance is well within the M.G.'s capacity.

No modification to the engine is necessary to fit the Shorrock Supercharger, and installation may be easily undertaken by any competent garage or owner-driver.

The Shorrock Supercharger—a fine example of precision engineering—will function over long periods with little attention. It is lubricated from the engine. Performance and reliability are greater than can be obtained with even a highly tuned unsupercharged car; indeed Shorrock Supercharging is the simple answer to all who wish to obtain maximum performance from their cars.

1250 C.C. M.G. ENGINE (TYPE XPAG) COMPARATIVE PERFORMANCE CURVES  
WHEN FITTED WITH A STANDARD SHORROCK SUPERCHARGER TYPE C75B

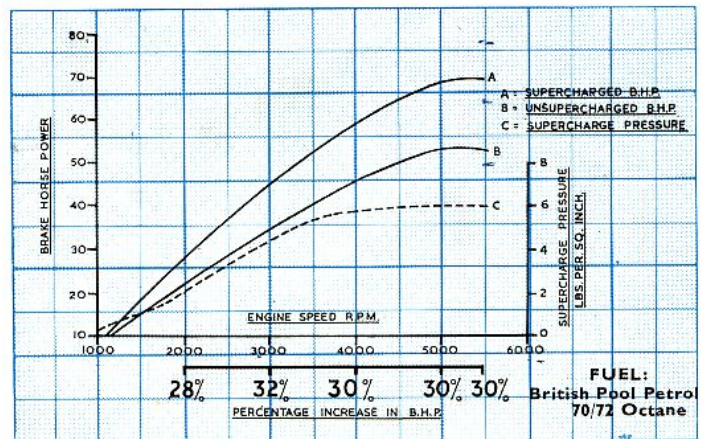

This graph shows the remarkable increase of power, and consequently of performance, gained by the M.G. when fitted with a Shorrock Supercharger.

# SHORROCK SUPERCHARGERS LTD



# Twenty Questions

Courtesy Al Moss  
May, 2008

# Your Questions Answered



## SUPERCHARGING

is the supply of mixture to the cylinders under even, forced pressure, instead of atmospheric pressure.

## DESIGN

1. What is the Shorrock Supercharger?

It is a positive displacement eccentric drum vane type compressor.

## NOISE

2. Is it noisy?

No, it is almost inaudible at all speeds.

## PERFORMANCE

3. Is it in operation all the time, and how will this benefit my car's performance?

Yes, it is in operation at all speeds giving additional power, improved acceleration, better hill climbing and top gear performance.

4. Is it practical for everyday use?

Yes, by giving much greater flexibility it increases the ease and pleasure of driving in traffic and at speed on the open road.

## POWER AND BOOST

5. What is the maximum increase in power and the maximum boost pressure?

The increased B.H.P. available varies between 30% to 50% depending upon the type of engine. This increase is obtained with 6-7 lbs boost.

## STARTING

6. How does supercharging affect starting?

Normally an improvement is effected.

## ALTITUDE

7. Is supercharging an advantage at high altitudes?

Supercharging compensates for the loss of power inevitable with lowered air density.

## FUELS AND CONSUMPTION

8. Does supercharging call for special fuels, and how is consumption affected?

Ordinary standard fuel is suitable and consumption increase is only 10%—15%, which gives a performance—economy figure in favour of the supercharged car.

## LUBRICATION

9. How is it lubricated, and what is the oil consumption?

It is pressure fed from the engine's lubrication system, and does approximately 3,000 miles to a gallon of oil.



## INTERCHANGABILITY

10. Can the supercharger be transferred from car to car?

Yes, if the engines are of similar capacities—consult our distributors who will gladly advise you.

## INSTALLATION

11. Is it difficult to instal, and is everything necessary supplied with the kit?

The complete installation may be fitted in approximately half-a-day and everything is supplied including carburettor, manifold pipes, fitting brackets, pulleys and belts.

## RELIABILITY

12. Does supercharging impair in anyway the life or reliability of the car's engine or chassis?

No, not with normal driving.

13. Should the car be run in before fitting a supercharger?

This is advisable but not essential.

14. Is trouble with cylinder head gaskets to be expected?

With the boost pressures normally employed no trouble should be experienced.

## MODIFICATIONS

15. Is it necessary to adjust or alter the valve timing in any way?

No.

16. Should the ignition system be altered or adjusted?

The standard distributor provides all adjustments necessary. Standard "touring" plugs should be replaced by plugs of the "sports" type.

17. Is a new carburettor or petrol pump required?

A new carburettor is necessary, and this is supplied with the supercharger. The present petrol pump is quite adequate as very little extra fuel is used.

18. Does the exhaust or cooling system require any modification?

None whatsoever, these are both satisfactory.

19. Should a higher back axle ratio be used?

For normal work the average axle and gear ratios are quite satisfactory. For competition work it may in some cases be desirable to modify the axle ratio.

## DRIVE

20. How is the supercharger driven?

By multiple vee belts from the crank shaft pulley. Belts have life of 15,000 miles approximately.



by



DOES IT GIVE MORE POWER?

Courtesy Al Moss  
May, 2008

**SHORROCK**  
SUPERCHARGERS LTD.



I'M JUST GOING TO FIT THE SHORROCK

For  
Noiseless, trouble-free  
performance fit a

# SHORROCK Supercharger

Courtesy Al Moss  
May, 2008

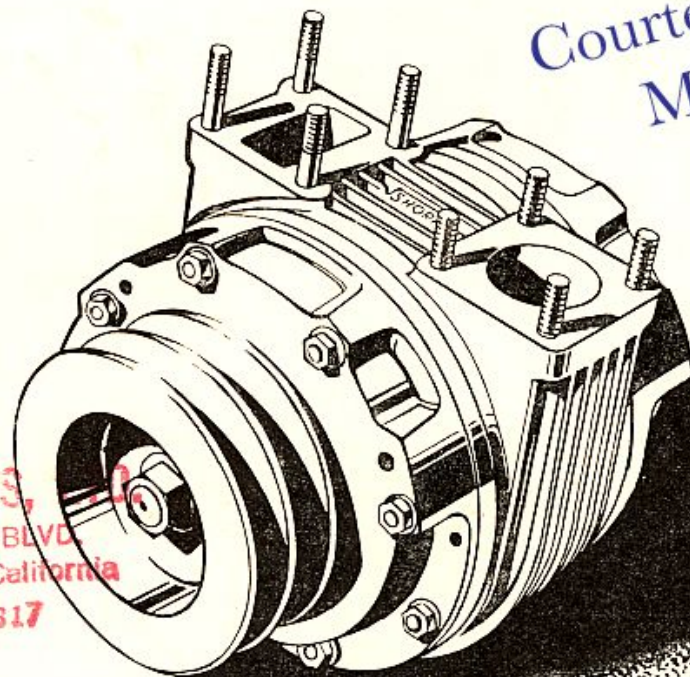

MOSS MOTORS, INC.  
5776 VENICE BLVD.  
Los Angeles 19, California  
WEBster 8-6317

Distributed in the United States of America by

**Autocessories, Ltd.**

WARSAW, INDIANA, U.S.A.

DIVISION OF ARNOLT CORPORATION

**SHORROCK SUPERCHARGERS LTD., COVENTRY, ENGLAND**

Made in England

015-2801652

