

# LUCAS

## TECHNICAL SERVICE

**OVERSEAS  
TECHNICAL CORRESPONDENCE  
COURSE**

**Section 2  
STARTING MOTORS**





# INTRODUCTION

---

The subject of Engine Starting related to Starter Motors and their service is not a difficult one if the general field of application is understood.

The basic requirements for the "Free Starting" of most classes of vehicle engines with which we have to deal are :—that in order to obtain "Free Starting" at a specified minimum temperature the engine has to be turned at a speed of round about 90 to 100 r.p.m. and this is generally referred to as the "cold cranking speed."

The equipment required to crank the engine may be regarded as a completely separate section of the electrical equipment as a whole, and will comprise simply, a Starting Motor, together with its switch, a battery of sufficient capacity to produce the current necessary to develop the "Torque" of the starting motor, and, lastly, the connecting cables.

Lucas and C.A.V. Starter Motors are available to cover a very wide range of engines from the small horse-power petrol engines, right up to the heaviest type of vehicle diesel engine, that is, the range of Starters in current production provides for the requirements of engines between 750 and 1,000 c.c. up to 8 and 10 litres capacity.

Until quite recently a number of the smaller light cars operated on the 6 volt system, but at the present time most engines up to about  $4\frac{1}{2}$  litres capacity operate on 12 volt, using Lucas Starters, and those between  $4\frac{1}{2}$  and 10 litres operate on 24 volt, and generally use C.A.V. Axial type starters which are outside the scope of this course.

The motors and complementary components with which we shall concern ourselves apply to engines up to about 4 litres capacity, and come within the electrical classification of "series" or "series-parallel" motors about which we shall say more at a later stage.

The outstanding characteristic of this class of motor is, that the turning power or "Torque" is at a maximum when the speed is at a minimum. This desirable feature makes it conveniently possible to produce a unit capable of turning a very cold stiff engine from the "at rest" position to whatever speed may be required to obtain "Free Starting."

At the moment the starter motor is engaged to the flywheel of a stationary engine, and the current applied, it will then exert its maximum power and also require the greatest amount of current. This may vary from approximately 250 amperes up to as much as 1,000 amperes according to the size of the engine, its temperature, the number of cylinders, compression ratio, the size of flywheel, and the general condition of stiffness, which is most prominent when it is new.

As the turning, or cranking speed of the engine increases from zero the torque required from the motor and the current required to produce it will become substantially less. So that, taking a typical example of say a 14 h.p. 4 cylinder car engine requiring current of 250 amperes to start it moving from cold, it may, when hot, turn over quite freely at more than 100 revolutions per minute with a current of 150 amperes or less.

You already know that a Battery specification is selected firstly, for its suitability to provide sufficient current for the coldest cranking condition likely to be needed for that particular engine.

Similarly a starter motor is selected to provide the maximum required torque, to crank the engine from the lowest specified temperature. Consequently, it is usual to specify, not only in regard to size but also "Lock Torque" in lbs.ft. at a definite current and voltage.

These figures are published as Workshop information and provide the necessary performance data to which all such units should be repaired if they are to be completely satisfactory when put back into service.

#### **PINION ENGAGEMENT AND DRIVE ASSEMBLIES.**

The next factor which has to be considered is the method of engaging and dis-engaging the starter motor driving pinion with the flywheel teeth, or what is more technically called the "Flywheel rack," and three methods of drive engagement are now in use for this purpose.

The first one, most commonly used on the engines of Light Cars or Trucks is the "Inertia Type" of starter pinion engagement. Secondly, for many of the heavy petrol engines and the new light diesel engines, the "Pre-Engaging" type of pinion and drive assembly is becoming increasingly popular. Thirdly, there is the "Axial Type" of electrically operated engagement so familiar in the range of C.A.V. Axial starters.

The principal component of the popular "Inertia" type Starter Drive consists of a pinion wheel assembled on to a screwed sleeve which is carried on the splined armature shaft of the motor. When the motor revolves the "Inertia" or dead weight of the pinion prevents it from turning immediately and it slides along the screwed sleeve, engaging with the flywheel teeth, the motor then "cranks" or turns the engine.

On the heavier type of pre-engaging drive the pinion is pushed into mesh manually and when fully engaged the current is automatically switched "on," when the motor commences to revolve and thus cranks the engine.

On the "Axial" type motor, the pinion forms part of a sleeve on the armature shaft. When current is switched "on" the complete armature and pinion assembly is revolved slowly and pushed forward into mesh with the flywheel. Upon completion of this engaging operation the main current supply is automatically switched "on" and engine cranking commences.

In addition to the engagement of the Starter Motor pinion the whole drive assembly must be flexible.

On the "Inertia" type drives this flexibility is obtained by adding a heavy coil spring which is compressible and thus absorbs the shocks of direct impact between Starter and Flywheel.

An alternative to this "Compression" spring is used for certain special application. This comprises a rather similar heavy spring, one end of which is anchored to the Armature Shaft and the other to the engaging pinion, thus allowing for a limited amount of flexibility by twisting of the spring. This is known as a "Torsion" Spring as used in the "Eclipse" type Drive Assembly.

On both the manually engaging and the "Axial" type drives, provision against shock load is made by inserting a spring loaded plate generally known as an Over-Run clutch, which will allow the pinion to slip when overloaded.

The standard Lucas type "Inertia" drive, by virtue of its extreme simplicity and satisfactory performance over many years will be found on the vast majority of cars and trucks, but even in this field problems occasionally arise. Very flexible engine mountings, engines with high compression ratios, advanced engine timings, ingress of swarf or grit, and other factors have necessitated the adoption of modifications to the original standard drive. These have taken the form of pinion restraining springs, rubber couplings, enclosed screw sleeve assemblies etc., until at the present time there are four main types of Lucas standard "Inertia" drives as well as the manually operated and Axial arrangement, all of which were primarily introduced to suit the engine makers particular requirements.

A proper understanding of these components is most important, and will be fully dealt with in the course of our study of "Starter Drives," together with service features such as correct pinion clearances, which have a most serious effect on flywheel wear and tooth damage

## STARTER SWITCHES.

A separate section of the course deals with Starter Switches and methods of operation, of which there is a variety.

The Starter Switch itself is a compact unit with ample current carrying ability for its purpose. Numerous methods of operating the switches are provided mainly for convenience and to meet the requirements of the vehicle manufacturers.

In the case of the popular cars and light vehicles, the method most commonly adopted is the provision of a "Cable Pull," or a "Push Rod." Alternatively it may be more convenient on many layouts to incorporate an operating solenoid in the starter switch itself in order to provide Push-Button operation at any desired point inside the vehicle. In turn the solenoid starter switch itself can be mounted on the Starter Motor, or at any adjacent location such as the bulkhead. Probably the majority of starter switch troubles arise as a result of badly adjusted cable controls and Push Rods which jam, in both cases causing excessive sparking at the switch contacts with ultimate damage and failure, accompanied by unsatisfactory engine starting meanwhile.

With the manually operated pinion engaging drive, the Solenoid Starter Switch is automatically closed by means of a small push switch after the pinion engages the Flywheel, and in the case of the "Axial" type Starters the current is automatically switched on after pinion engagement, by a switch built into the motor itself.

## WHY 12 VOLTS.

Some reference may be made to the effective differences when using the 6 or 12 volt systems for engine starting, bearing in mind that the 6 volt equipment is no longer produced for cars and vehicles.

In practice, a 12 volt starter will develop something approaching twice the brake horsepower of its 6 volt counterpart of the same dimensions. This is due in the main to the fact that in comparable systems of equal power, the 6-volt circuit will be required to take double the current of the 12-volt system. With this increased current, the power loss due to the constant resistance of the circuit, i.e. cables, earth return and brushgear, considerably diminishes the power available for conversion by the starting motor. These power losses are, of course, proportional to the square of the current.

Arising from the same fundamentals, another serious difficulty is present with 6 volts. Under certain engine conditions, great difficulty is experienced in keeping an inertia-engaged pinion in mesh with the flywheel for a sufficiently long time to effect a start. This is because the lower torque developed in the 6-volt starter is insufficient to accelerate the armature rapidly enough to maintain engagement with the flywheel ring as the engine fires, or even goes over compression. This difficulty can be overcome by the use of manual or pedal engagement where the pinion is physically held in mesh with the flywheel. Such systems, however, involving as they do the use of an outboard bracket, engagement mechanism and over-run clutch, necessitate considerable increase in cost, weight and complication. It might appear at first sight that a small British engine of 1.5 litres capacity would require less power to crank than an American engine of 2-3 times the capacity. Due to factors inherent in small engines, particularly the increased surface/volume ratio, that is not so. A recent test in our cold room established that at 10°F., using S.A.E.20 oil, a British 4-cylinder engine of 1.535 litres capacity required 16% more power to crank at the 90 r.p.m. necessary for a start than a 3.670 litres 6-cylinder American engine at the 50 r.p.m. it needed. This is representative of our experience.

Finally, you will note that a good deal of attention is given to Servicing and Fault Finding in our Engine Starting Studies, and this will no doubt receive close attention, because unsatisfactory performance in Service almost always arises from simple detail causes which can very easily be overcome by the requisite "Know How," rather than by any inherent fault either in the design and workmanship of the starter motor, or at the engine assembly end; although occasionally problems do arise with starter pinions and Flywheel Rings which are concerned with the engine assembly.

In order to assist those Students who may have no knowledge of electrical matters the first section of the course deals in a simple manner with the method of operation of the Electric Motor particularly as applied to Starter Motors. If difficulty is experienced in fully understanding this Section there is no need to be in any way discouraged. Proceed with the other Sections when at a later date, particularly with increasing practical experience, it will be found that the subject will clarify itself.

# CONTENTS

---

## **PART 1.**

### **Working Principles.**

Production of turning movement — magnetic effect of an electric current — concentrating a magnetic field — production of the main field — producing the armature field — inter-action of the two magnetic fields — commutation — main field in practice — earth brushes — the armature — wave winding — lap winding — brush positioning — starter internal circuits — types of fields — torque — torque, speed, current, graphs — transmission of turning effort — pinion and flywheel.

## **PART 2.**

### **Symbols and Model Interpretation.**

Current production starters — the M.35G. starter — the M.418G and M.45G. starters.

## **PART 3.**

### **Starter Drives.**

Inertia and crash type drives — inboard or outboard operation — the "S" type drive — the "SB" type drive — rubber coupling drives — pinion engagement — pinion and flywheel wear-out-of-mesh clearances — armature end float — faulty engagement and dis-engagement — assembly and lubrication.

## **PART 4.**

### **Service Testing on the vehicle.**

Starter circuits — switches — switch adjustment — testing the starter system — checking procedure — battery check — voltage drop — testing switches.

## **SUPPLEMENT No. 1.**

### **The Lucas M.45G. Pre-engaged Starter.**

General view — arrangement of starter and flywheel — the wiring circuit — the pilot switch — the armature brake — the clutch — pilot switch adjustment procedure — maintenance.

## **QUESTION AND ANSWER PAPERS**

### **STUDENT'S QUERY PAPER**

### **AIR MAIL REPLY ENVELOPE**

---

## **COPYRIGHT**

*All rights reserved. No part of this  
publication may be reproduced  
without permission.*

JOSEPH LUCAS (SALES AND SERVICE) LTD., BIRMINGHAM, 18, ENGLAND.

# Working Principles

## THE STARTING MOTOR

It must first be understood that energy cannot be created from nothing; it can however be converted from one form to another.

In the case of the starter motor, we employ electrical energy — the electrical current from a battery — and convert it into mechanical energy, the type of energy required to turn over the engine of a motor vehicle.

To understand how this conversion is brought about — how we can use the battery current and produce turning movement — we must consider how two magnetic fields can interact and produce such a movement. We can then go back a stage further and see how these magnetic fields are produced from the battery current.

## THE PRODUCTION OF TURNING MOVEMENT

These illustrations show two magnetic fields. The main one is produced by the horseshoe magnet and the second, which we shall call the "armature magnetic field," exists around the bar magnet.

In the combined picture at the bottom, this bar magnet is pivoted at the centre.

Everytime the two magnets are brought into close proximity to each other, their fields interact, become distorted and, in trying to revert to normal, force the pivoted magnet into movement.

But the movement will be restricted: the bar magnet will turn only as long as like magnetic poles are next to one another. You can see that the two North Poles repel each other, so do the two Souths producing the turning movement. (You will remember this fundamental rule of magnetism.) But, when the magnet has rotated through half a revolution, unlike poles will be together and no further movement will occur. One way to continue the rotation would be suddenly to reverse the polarity of the bar magnet i.e. change over the North and South poles.

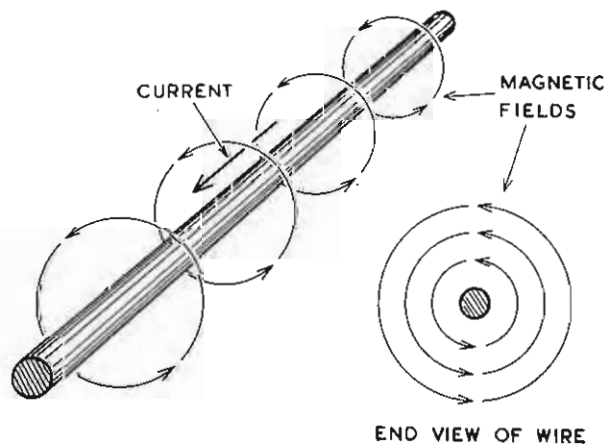
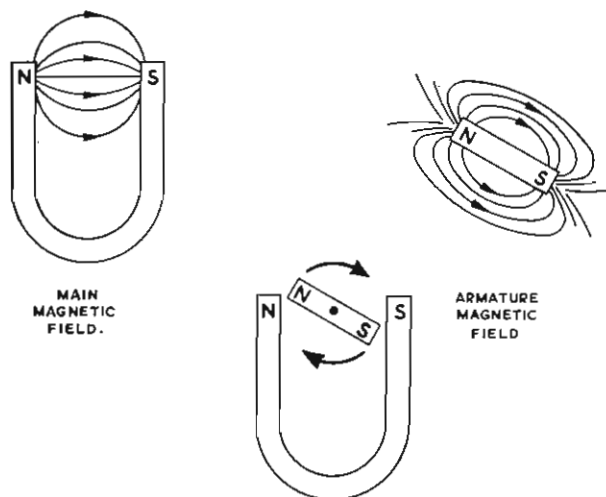

## THE MAGNETIC EFFECT OF AN ELECTRIC CURRENT

In the build-up of our starter motors, we do not use permanent magnets to produce the two magnetic fields: we make use of the electric current from the vehicle battery.

Here we show current passing through a conductor in the direction indicated by the arrow. A magnetic field will be produced around the conductor. The lines of force of the magnetic field are formed in a definite pattern, dependent upon the direction of the current flow. In this case, the pattern is anti-clockwise in form, as we have indicated by the circular arrows. A cross-section of the wire is also shown, illustrating the circular pattern of the magnetic field.

## CONCENTRATING THE MAGNETIC FIELD

Using a coil of wire instead of a single conductor greatly increases the magnetic effect. The soft iron core adds to this by concentrating the lines of magnetic force into the coil area. The result is a powerful magnet.

The polarity of the magnetic field varies with the direction of the current flow. In this particular case the current flowing from battery positive through the coil to the negative produces a North pole on the left and a South on the right. If the battery were connected the other way round, thus reversing the current flow through the coil, the polarity of the field would also be reversed.

Having established that a magnetic field can be produced round a coil of wire, let us consider how we employ two such fields in the starter motor.

We will deal first with the main magnetic field—if you remember, this was provided by the horseshoe magnet in our original simple illustration.

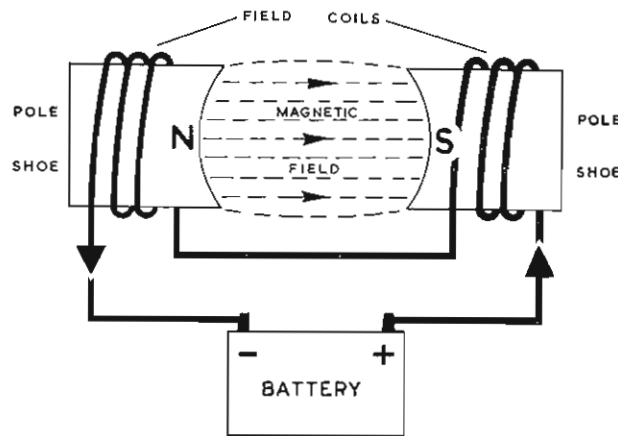
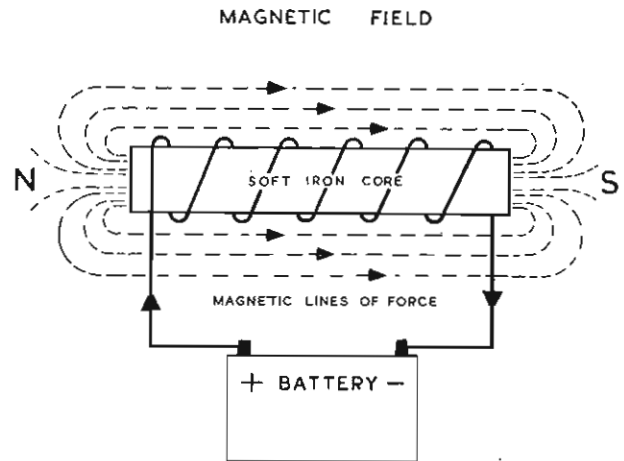

## PRODUCTION OF THE MAIN MAGNETIC FIELD

The main field is created by using soft iron which becomes easily magnetised by current flowing through the surrounding coils of wire. These coils are known as field coils and the blocks of soft iron, specially shaped to concentrate the magnetic strength into the gap, are called pole-pieces or pole-shoes.

All we have done in effect is to cut the soft iron of the previous illustration into two halves and shape the end of each half. In addition, the coil winding has been divided into two. The windings are so arranged that the pole-pieces are of opposite polarity.

In this particular case, a north pole is formed on the left and a south on the right. The field magnets we have produced remain fixed at this polarity.

## PRODUCING THE ARMATURE MAGNETIC FIELD

And now let us consider the second magnetic field, generally termed the "armature magnetic field." You will remember that this was formed by the pivoted bar magnet in our early illustration.

This loop of wire, passing battery current, produces an equivalent effect. The current flow in the wire gives rise to a magnetic field whose plane is at right angles to the loop itself — as we have indicated by the shaded area, which you can consider as representing our original bar magnet.

With the current flowing round the loop in the direction shown by the arrows, a north magnetic pole will be produced on the left, and a south on the right. If we reversed the current flow, we should also reverse these poles.

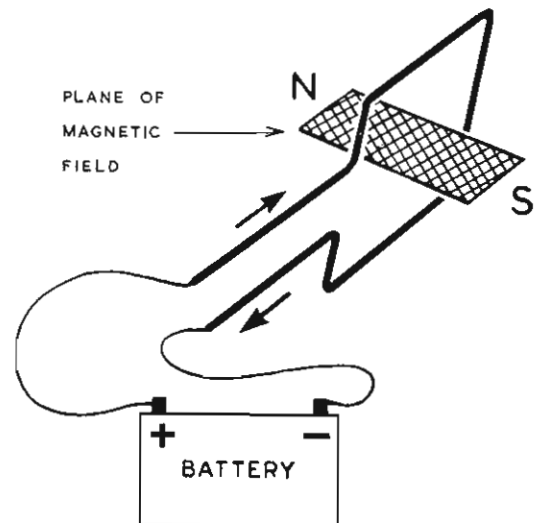

## INTERACTION OF THE TWO MAGNETIC FIELDS

Here we show the armature loop in the magnetic field of the main magnet. The two fields interact, the two norths and the two souths repelling one another, thus forcing the pivoted loop into movement.

If the battery current still remains in the same direction, the loop will cease rotating after half a revolution, that is when the north and south poles line up.

However, if we could arrange matters so that as the loop turns, the pole coming round to the fixed north pole of the field magnet was itself always north; and that approaching the fixed south pole was always south, the repelling action would invariably take place, continually impulsing the loop as it rotated.

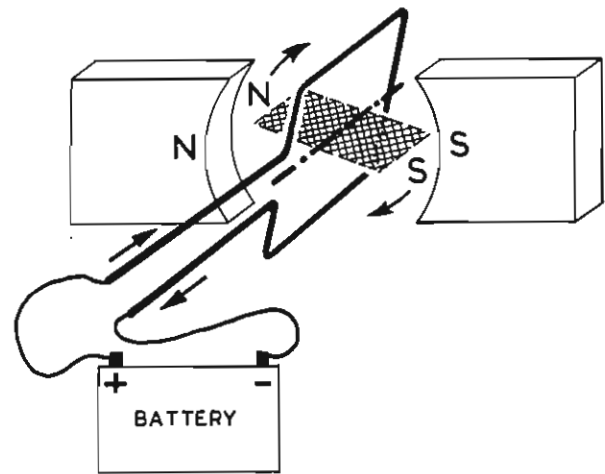

## THE PRINCIPLES OF COMMUTATION

This effect is achieved by joining the ends of the loop to two metal segments before they pick up the battery current.

Brushes actually form the contact between the battery and the segments.

Let us consider the top left hand illustration first, where the black half of the loop is at the top, with its end connected via the segment to positive battery. In this position, the current flowing through the loop produces a north pole opposite the fixed north pole of the field magnet; and a south opposite the fixed south pole. Repulsion occurs and the loop begins to rotate.

Now look at the bottom right-hand sketch, where you will see that the loop has moved through half a turn, so that the white section is now on top. But, you will notice that the magnetic field produced by this section is still north in polarity; in other words it will still be repelled by the fixed north pole. Likewise, the black section of the loop which previously produced a north pole, is now producing a south as it moves opposite the fixed south pole. Repulsion will therefore occur again and the rotation will continue.

What has happened is that the direction of the current in the wire itself has changed because the segments have moved under brushes connected to opposite sides of the battery. You can see in the left-hand illustration that the black half of the wire loop is connected to positive battery; whereas in

the right hand illustration it is connected to negative battery, which means that the current flow in that section has reversed. The same can be said for the other section.

With a change in the current, comes a change in polarity. As the loop rotates, therefore, the two sections assume the polarity of the fixed poles they approach.

We shall be discussing this reversal effect, known as commutation, a little later on.

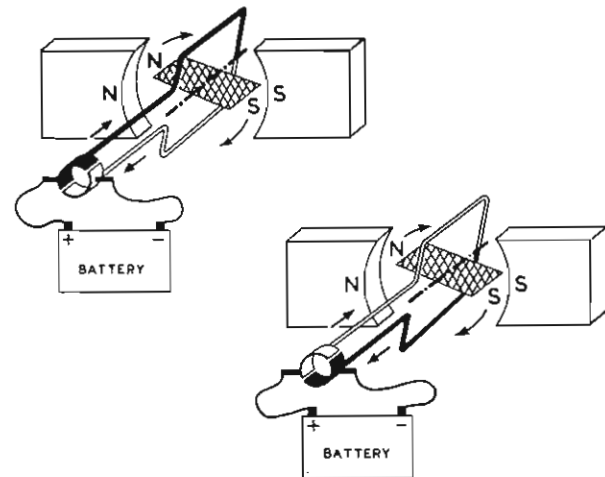



## OPPOSING FIELDS

Let us examine this interaction of the two magnetic fields a little more closely, to give you a more graphic idea of how the turning movement is produced.

The illustration shows the main field produced by the north and south pole pieces. We also show, in cross-section, the magnetic lines of force surrounding the armature loop.

Imagine the current at "A" flowing through the conductor towards you. The magnetic lines of force produced around "A" in an anti-clockwise direction will interact with the lines of force of the main magnetic field between the north and south pole-pieces. The result of this interaction between the two fields is a distortion of the lines of force. A strengthening of the field occurs under the conductor at point "A."

Now magnetic lines of force have elastic properties, and, if we regard these distorted lines of force as stretched elastic threads which tend to straighten themselves, we can see that a pressure will be exerted under the conductor at point "A" and the loop will be urged round in a clockwise direction.

Similarly, it can be seen that at point "B," where the current through the conductor and hence the

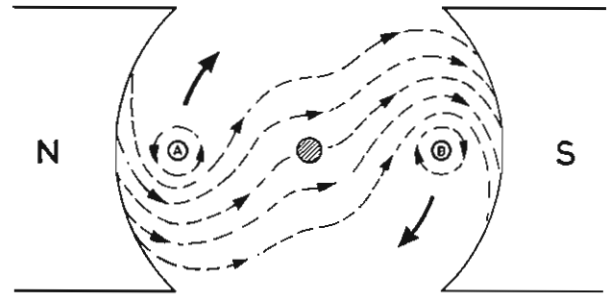

magnetic field is in the opposite direction, that a strengthening of the field will occur above the conductor and the pressure exerted will assist the movement of the loop in a clockwise direction.

Thus by the interaction of two opposing magnetic forces, mechanical energy or more specifically turning movement has been produced from electrical energy.

We shall now consider the more practical aspects of the Starter motor, beginning with the production of the main magnetic field.

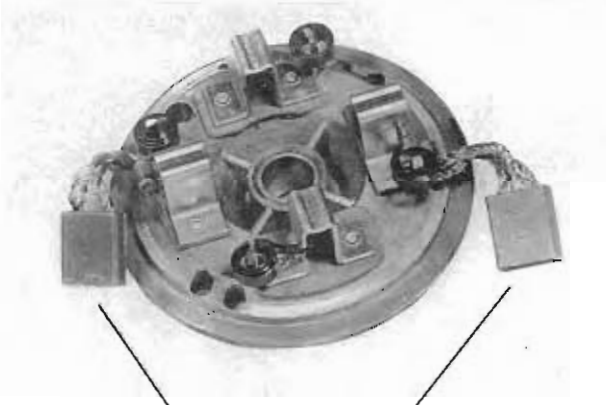
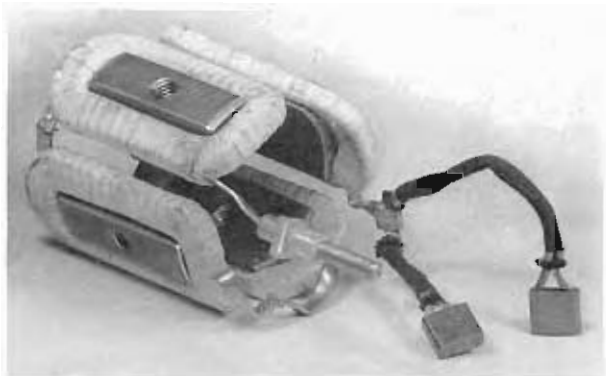

BRUSHES EARTHED TO  
STARTER END BRACKET

## THE MAIN FIELD IN PRACTICE

The theoretical motor we have discussed so far used a main magnetic field of one North and one South pole. In practice, the majority of our machines use four pole shoes surrounded by field coils, thus producing a concentrated field with four magnetic poles.

The field coils are wound so as to produce alternate North and South poles.

The two brushes and the main terminal visible in this picture are the means by which the battery current enters and leaves these field coils.

In this particular arrangement, the four coils are wound in series, i.e. the current passes in line from one coil to the next. As this current is normally in the region of 200-300 amperes, heavy copper strip is used for the coil windings. For the same reason, two brushes are necessary, each taking half the total current consumption, to avoid electrical losses and overheating. The brushes themselves contain a high percentage of copper mixed with the carbon. We shall be referring to these two brushes from now on as the insulated brushes. You can see that the leads to them are covered by fairly heavy braiding.

## EARTH BRUSHES

A corresponding pair of non-insulated or earth brushes is also used in the starter, again with the aim of passing the heavy currents without excessive losses which result in overheating.

When we deal with the starter circuit, you will see exactly at what point these earth brushes fit into the picture.

## THE ARMATURE

The second magnetic field in our starter motor is produced in practice by this armature which, although far removed in appearance from our simple wire loop and two segments, is essentially the same. Instead of one loop, we use many, but each end of every loop is still connected to a copper segment. All the segments are insulated from one another and rolled together to form what is called a commutator. This provides the running surface for the brushes which carry current to and from the armature windings.

The whole assembly is built round a solid steel shaft. The core, which actually carries the windings, consists of a whole series of soft iron laminations. (You will remember how iron helps to concentrate the magnetic field.) Laminations are used instead of solid metal, to reduce the heating effect of harmful electric currents known as "eddy currents" which are produced when the armature revolves in the main magnetic field. The laminations offer a sufficiently



high resistance to render these currents harmless as far as heating effect is concerned.

Having shown you the complete assembly, let us examine the components more closely.

## INDIVIDUAL ARMATURE COMPONENTS

Here you see the individual components. Let us commence with the steel shaft which forms the centre of the whole assembly. The short splined section on the left carries the commutator. The next splined section is larger in diameter and longer to carry the soft iron laminations of the core. The heavy splined section on the right does not concern us at this stage as it forms part of the drive assembly.

The commutator is built up of individual copper segments, with an insulating strip between adjacent segments.

The commutator "risers" provide convenient soldering points for the ends of the armature loops.

These armature loops, aptly termed "hairpins," pass through the slots in the laminations; the ends are then twisted so as to connect with the correct commutator segment.

To continue our study of the starter motor, we must examine the method of interconnecting the individual loops in the complete armature winding.

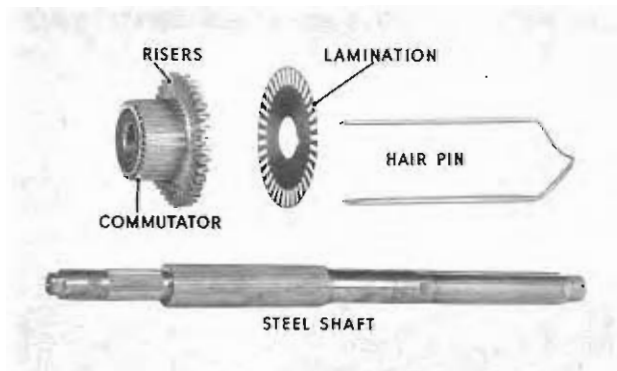

## METHOD OF ARMATURE WINDING

We have reduced the number of loops in the winding so as to simplify matters, which also means of course that we reduce the number of segments in the commutator accordingly. Our aim is to illustrate the order in which each loop is connected.

If we start at segment 1, we can follow the lower loop round to the back of the commutator where it ends at segment 2. A second loop then continues the winding round to segment 3. From 3, we pass to 4; from 4 to 5 and so on.

You will notice that the ends of each loop are staggered to opposite sides of the commutator, being in practice always  $180^\circ$  apart, less one segment.

This method of winding is known as "wave winding."

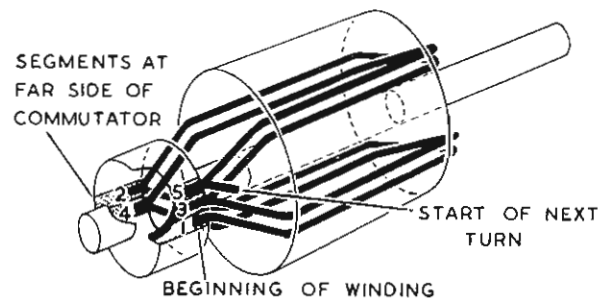

## THE ARMATURE MAGNETIC POLES

Here you see the magnetic poles produced by these windings. The current flow in them is such that two north poles are formed at the exterior of the armature and on opposite sides.

If you imagine the remainder of the windings in position round the armature, at right angles to the ones shown, the current flow in them would be arranged to produce two south poles.

The total effect would be to produce four alternate north and south poles round the exterior of the armature.

These are the four magnetic poles which oppose those of the main field of the pole-pieces.

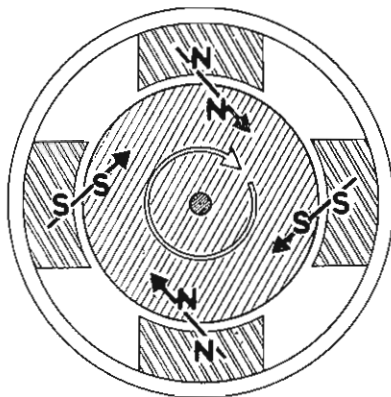
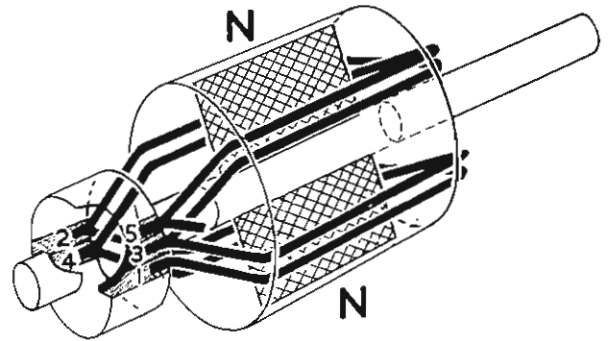

## THE OPPOSING MAGNETIC POLES

Here the illustration shows the opposing polarities of the two magnetic fields. The main field produced by the four pole pieces is shown surrounding the alternate north and south poles of the armature field.

You will remember that the poles must oppose one another for repulsion to occur and the armature to rotate.

## THE ARMATURE — WAVE WINDING

Although this diagram may appear complicated at first sight, it merely represents in diagrammatic form what we have already shown you — that is, the method of interconnecting the individual loops in the wave-wound armature.

We shall go a stage further and follow the path for the battery current round the armature from where it enters at one of the positive or earth brushes to the adjacent insulated or negative brush — i.e. the point at which the current leaves the armature.

Let us follow the windings, commencing from the positive brush, in position on the No. 1 segment. The first loop carries the current to the No. 2 segment at the opposite side of the commutator. You can see that the two ends of the loop are 180° opposed, less one segment. From segment 2, the winding loops round to 3 — that is the segment next to the starting point. The current path continues to segment 4 and from there to 5; from 5 to 6 and so on to number 11, which is the segment under the negative brush. This completes one path for the current from one positive brush to one negative.

But we have simplified matters here for the sake of clarity; there is actually another current path from the positive brush on segment 1 round the armature in the other direction to the negative. This means that the battery current is passing through the whole of the armature windings, producing a strong magnetic field.

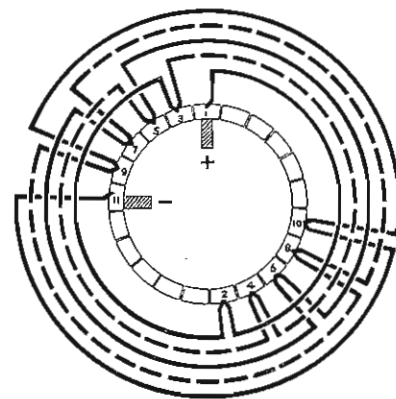

The magnetic effect will further be multiplied by the current flowing between the other two positive and negative brushes which we have omitted. These two are joined in parallel with the ones shown here and will be passing half the total current consumption of the starting motor.

In a production model, there are usually nine commutator segments between brushes of opposite polarity, which of course further increases the number of armature windings and accordingly the magnetic effect. Wave-winding the armature in this way, puts all the windings in circuit when the brushes are passing current.

## COMMUTATION

In the last diagram, we followed the current path round the armature between one positive and one negative brush ; but we considered it in a stationary position. We must now show what happens when the armature begins to turn.

Look at the top illustration first. It shows the brushes in position on segments number 1 and number 11 — in other words the brush — segment relation is that of the previous picture. But we have dispensed with the windings not immediately concerned with the changes that take place when the armature begins to rotate. Thus segment 3 is joined directly to segment 11, instead of being looped via the intermediate segments, 5, 6, 7, 8, 9 and 10.

In the top illustration then, current enters the armature via the positive brush on number 1 segment. Here the current splits into two, one half indicated by the arrowed black line travelling clockwise via segment 2 to segment three ; then still clockwise from 3 via 4 to 11. The other half of the current would travel round an equal number of windings to the negative brush on segment 11, but in the opposite direction. The start and finish of these other windings is shown by the short arrowed white lines.

Now consider the lower illustration. The armature has rotated so that the brushes are now on segments adjacent to the previous ones — i.e. positive brush on segment 3 ; negative on segment 13.

Now, you will remember from our earlier simple illustration of commutation that for the armature to continue rotating the magnetic poles produced by it must always oppose the fixed poles of the main field magnets. In other words, some change must take place to maintain this repulsion by like poles.

In the lower illustration, then, current will now flow into the armature at segment 3. It will split as before into two halves, one half continuing clockwise round the armature via segment 4 to segment 11 — i.e. in the same direction as before in this part of the winding. The current flow continues clockwise from 11 via 12 to 13 taking in an additional loop and segment.

But the other half of the current is anti-clockwise in direction from segment 3, travelling round the loop via segment 2 back to segment 1 — i.e. it opposes the previous flow in these two loops — just look at the top illustration again and see how the direction of the current has changed from clock to anti-clock.

Summing up then : while the current flow in these two loops has reversed, the overall effect is to maintain the same direction of current in all the other windings. Magnetically, this means that the original polarity of the four armature poles has not altered despite the fact that the armature itself has rotated one set of segments. If then, armature *north* poles were originally produced opposite the main *north* poles, the same condition would remain in the new position and repulsion would again occur to continue the rotation.

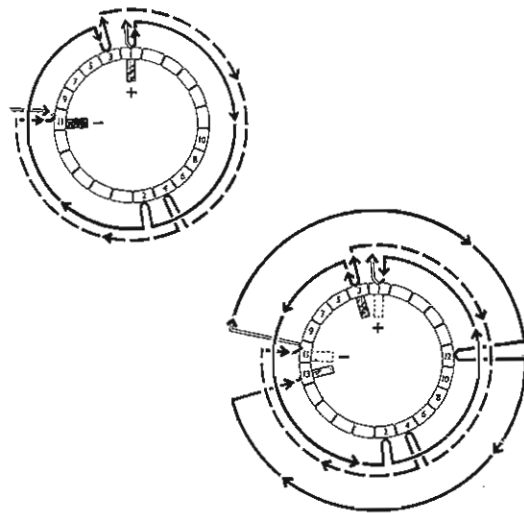

In practice, therefore, we can consider that the commutator, in reversing the current flow in two loops, ensures that the original magnetic pattern of the armature field remains constant, north poles invariably being repelled by north poles ; south poles invariably being repelled by south poles.

The exact moment at which the reversal of the current occurs in the two loops is all important to the correct running of the starter motor in service.

It is arranged to take place when two adjacent segments are making contact with the same brush. As the brushes are wide enough to cover two segments, this condition is always present no matter what the position of the armature.

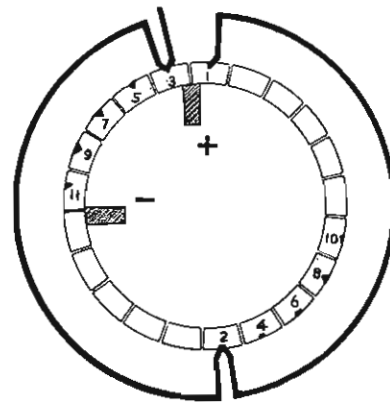

Here we show the positive brush making contact with segments 3 and 1. This effectively shorts out the two loops between these segments at the moment when the current reversal is taking place. The commutation may be regarded as perfect if the reversal is completed before segment 1 is clear of the brush. On the other hand if this segment leaves the brush before the complete reversal of the current, sparking will occur between the brush and segment, which will be extremely injurious to both.

## BRUSH POSITIONING

A further word now about the positioning of the brushes in relation to the magnetic fields. For the sake of clarity we shall once more revert to our early two pole example.

As we have seen, in the starter motor there are two fields; the main field shown in the top picture and the armature magnetic field shown in the bottom picture. These fields are at 90° to each other, the main field running horizontal, the armature field vertical.

You will observe that in the second illustration the main concentration of the magnetic field is centered round those conductors opposite the pole shoes, leaving neutral points along the vertical line. This is normally referred to as the "Geometric Neutral Plane."

The starter brushes must be positioned in the neutral plane to prevent excessive sparking taking place when current is passing between them and the commutator segments.

But a complication arises. The two magnetic fields of the starter motor cannot possibly co-exist without some interaction. We stated right at the beginning

that the turning movement was actually due to this interaction between the two fields.

The resultant field is shown in the illustration below. You will notice immediately that the neutral plane is no longer vertical: it has moved due to the flux distortion. The neutral points, in which the brushes must be positioned, have been moved against the rotation of the armature — and, to obtain sparkless commutation the brushes must follow suit. We have indicated the correct brush position, on the new neutral plane — technically known as the "Magnetic Neutral Plane."

If the rotation of the starter were now reversed, the neutral axis would swing over to the other side and the brush position would have to be altered to correspond. This theory has a direct practical bearing.

In the production of our starter motor components, the end brackets which hold the brushes are designed with clock and anti-clock fixing holes so that the brush position may be varied according to the rotation of the machine.

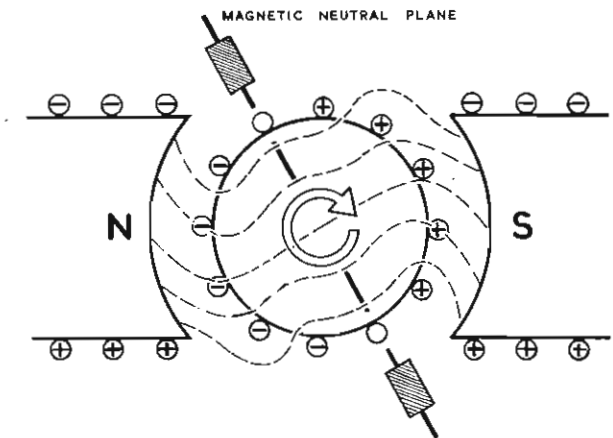
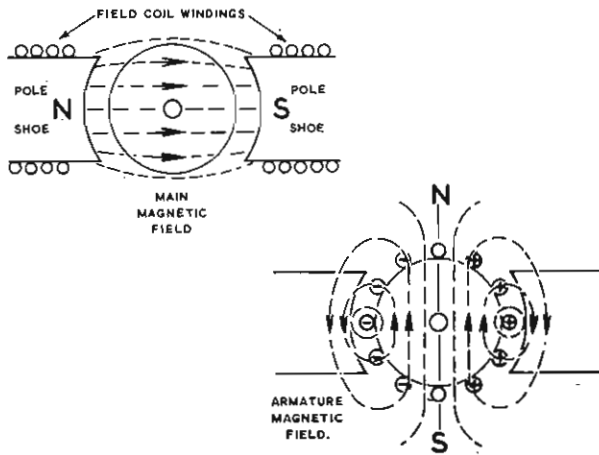

## STARTER INTERNAL CIRCUIT — (SERIES FIELD)

Let us now examine the internal arrangement of a typical starter motor with a view to tracing the circuit path through the fields and armature.

You have already seen an actual photograph of the four field coils depicted here. You will remember they were wound so as to produce alternate north and south poles and that they were all in series with one another. If you start from the end of the black line at the top of the picture and follow the winding through, you will see this is the case. The pair of insulated brushes then connect with the armature commutator. The circuit continues through the armature windings to the pair of non-insulated or earthed brushes, which we showed you earlier connected to the starter end-bracket.

This means therefore that the four field coils are electrically in series with the armature windings.

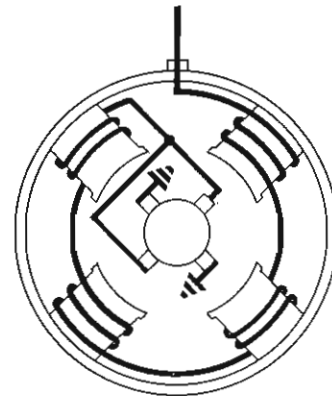

Thus current flowing from the vehicle battery will at once energise the field coils and the armature, producing the necessary two opposing magnetic fields.

This type of starter motor is known as a "plain series motor."

## STARTER INTERNAL CIRCUIT (SERIES PARALLEL FIELD)

Another internal arrangement used in our production Starters employs a series — parallel field.

The field circuit is divided into two halves, each in parallel with the other, thus dividing the electrical load. Both halves of the circuit are, however, still in series with the armature windings. Thus this starter motor still remains a series type of machine.

By assembling the field coils in parallel, it is possible to pass a somewhat greater current and obtain an overall increase in the mechanical energy developed, or torque as it is called.

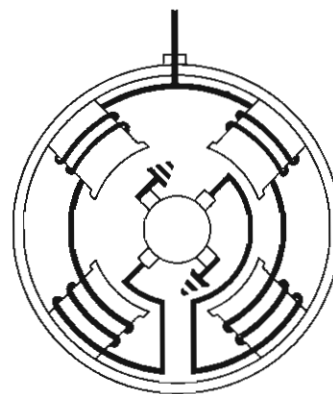

## THE COMPLETE ELECTRICAL CIRCUIT

Here you see the starter motor in circuit. The external cable layout to the motor is shown, basically as it would appear on a vehicle. The two components necessary are the battery to supply the current and of course a switch to control the current supply to the starter motor.

We have used a plain series machine in this circuit, but it could be directly replaced by the series-parallel type.

Let us follow the circuit through, commencing at the battery. We shall assume that the starter switch is closed.

A heavy cable connects the battery to one side of the switch. The circuit continues across the contacts in the closed position to the starter motor. It carries on round the four field coils in series via the two insulated brushes to the armature. The pair of earth brushes complete the circuit through the metal of the starter end bracket to the body of the machine, which is bolted to the vehicle chassis or earth. This earth connects with the battery earth terminal which is also strapped to the chassis.

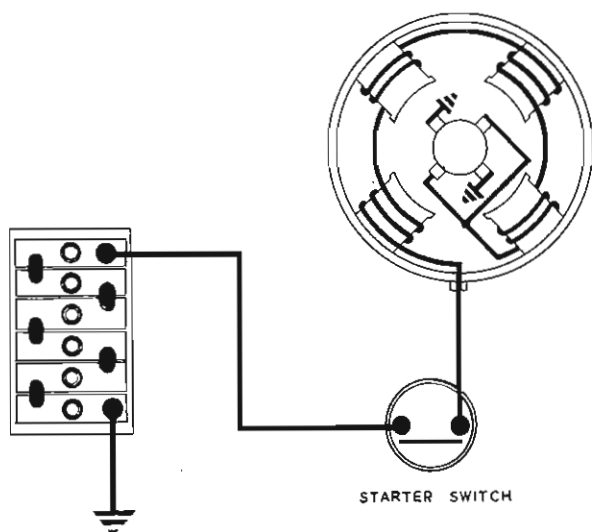

## TORQUE

Let us now take a closer look at the expression "Torque," which is the term used to define the turning movement or effort produced by the starter motor.

A simple illustration will suffice to acquaint you with the significance of the term.

If a force of 20 lbs. is applied to an engine crankshaft through a leverage of 12 inches, the turning effort produced would be :

$$20 \times 1 = 20\text{lbs./ft.}$$

The same unit of measurement i.e. lbs./ft. is used to express the turning effort developed by the starter motor when this effort is applied to the engine crankshaft via the flywheel.

But, to produce an equivalent 20 lbs./ft. torque at the engine crankshaft, the torque developed by the starter motor need only be 2 lbs./ft., due to the mechanical aid of gear ratio of 10 : 1 between flywheel and pinion.

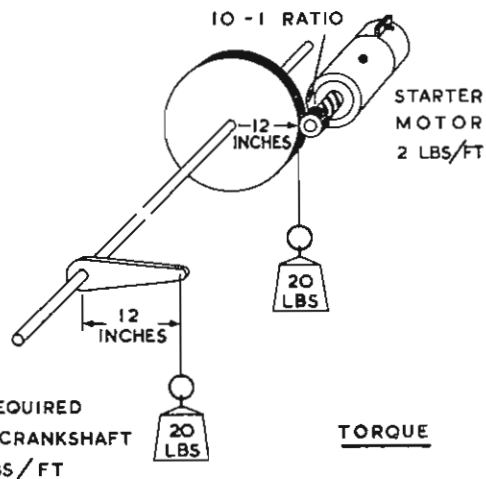

## LOCK TORQUE TEST

For test purposes, the torque produced by the starter motor is measured with the starter taking current, but with the armature shaft prevented from turning by a brake or clamp. The torque produced by the starter when trying to turn against this brake is termed the "Lock Torque" and the test, quite logically, the "Lock Torque Test."

The measurement can be taken directly from the armature shaft or via a test-bench flywheel.

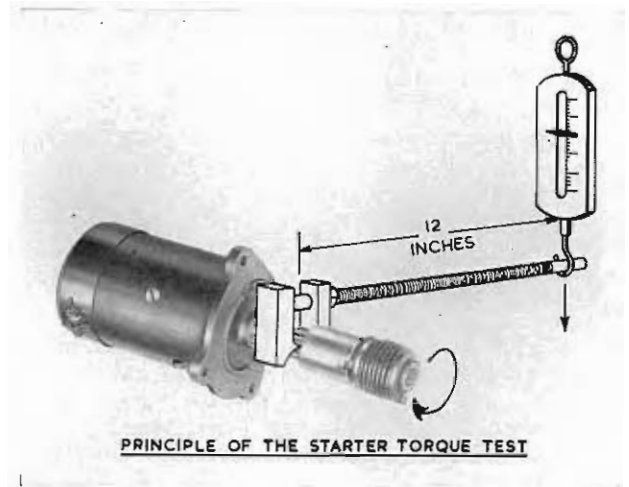

## BATTERY CAPACITY REQUIRED

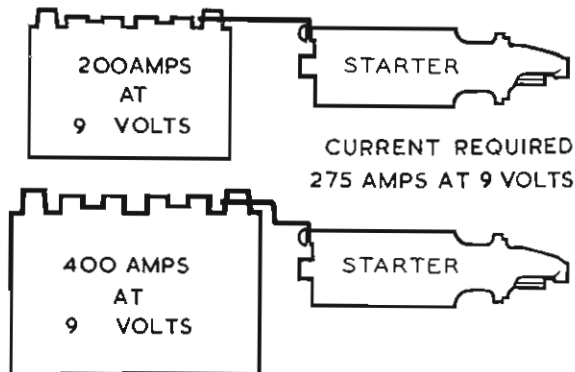

## BATTERY CAPACITY — ITS IMPORTANCE IN RELATION TO ENGINE STARTING

In connection with the performance of the starter motor, the importance of the battery must not be forgotten. Owing to the very heavy current taken by the starter, there is quite an appreciable drop in the battery voltage. The performance of the starter motor is therefore largely dependent upon the size of the battery employed. A battery of ample capacity is essential, otherwise the heavy discharge current will result in an excessive voltage drop which will limit the current available for the starter motor, and in turn reduce the torque developed.

In this case, you see, we need a current of 275 amps. at 9 volts. The top battery won't give us this current ; it can only supply a maximum of 200 amps at this voltage. The other, larger capacity battery will, with some to spare.

## THE TRANSMISSION OF THE TURNING EFFORT

We must now show how the torque or turning movement we have produced is transmitted to the vehicle engine ; in other words how the motor we have created becomes a starter motor.

This picture shows you one of the many different types of starter drives. The pinion engages with the flywheel, thus transferring the turning movement of the starter armature shaft to the engine crankshaft.

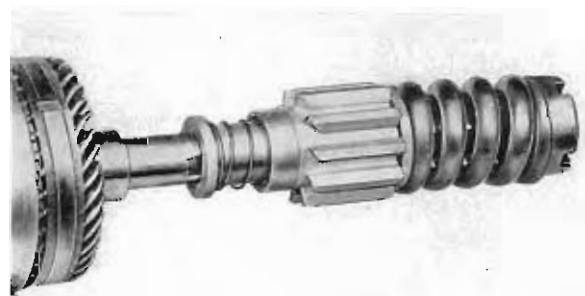



## PINION AND FLYWHEEL

The pinion and flywheel can be seen from this picture.

The pinion to flywheel ratios vary usually from 9—1 to 14—1 but are generally in the order of 9 or 10 to 1 on modern vehicles.

## CRANKING SPEEDS

In order to turn this flywheel at sufficient speed to start the engine, a minimum "cranking speed" of approximately 90 to a 100 r.p.m. is required. Cranking speeds are usually stated as "cold cranking speed" or "hot cranking speed." Obviously the effort required to turn over a warm engine is far less than that for a cold engine, when the oil is thick.

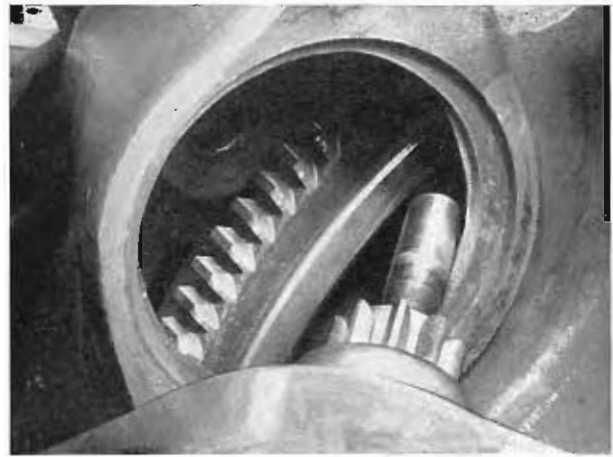

## BREAKAWAY TORQUE

We must discuss one further term in connection with starter motors and engine starting in general :

"Breakaway Torque"—the torque required to move the engine from rest, that is to overcome friction, oil viscosity, compression etc.

This breakaway torque is usually of short duration, but it is evident that it represents the maximum turning effort the starter motor must produce.

Fortunately, however, the main characteristic of the series motor is that it produces its maximum torque at the beginning of the starting operation, that is when it is most needed.

## GRAPH — TORQUE, SPEED, CURRENT

Here we have plotted "Torque" and "Current" against speed in R.P.M. and indicated the starter terminal voltage.

You can see that the torque curve falls from the maximum as the speed of the starter increases. It is this characteristic which renders the series type of motor particularly suitable as an engine starting motor.

And furthermore, when the starter armature rotates in the magnetic field, a voltage known as a "back EMF" will be induced into the windings, which is proportional to the speed of rotation. As this induced voltage is in an opposite direction to the supply voltage, it opposes the latter. The current drawn from the battery therefore decreases as the speed of the motor increases. You can see this from

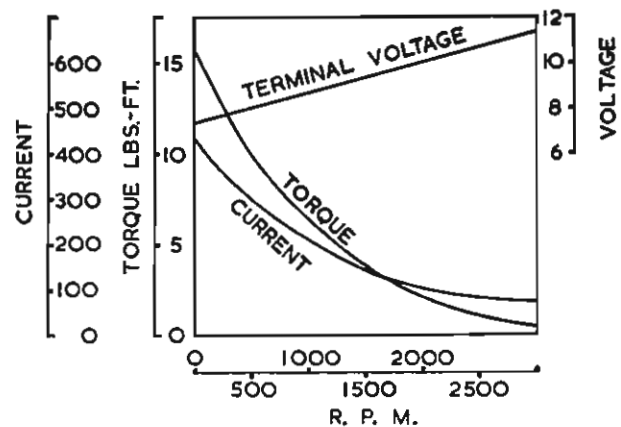

TORQUE SPEED CURRENT CURVES

the current curve. The starter terminal voltage will rise as the load decreases; and as the current drops, so the torque decreases; in other words, the least torque is produced when the starting load is at a minimum.

One further characteristic of the series motor is that its speed varies appreciably with load variation. Particularly is this so with light loads, where the speed increases at a very rapid rate, so that under no-load conditions the motor may attain really dangerous speeds. These series motors should therefore *never* be allowed to run continuously without load.



# Lucas Starters—Symbols and Model Interpretation

## CURRENT PRODUCTION STARTERS

Having discussed the theory of the starter motor and explained several terms essential to the understanding of engine starting, we shall now show you the practical application of all this theory, dealing with the various types of Lucas Starters.

The power developed by our Light Car Starter Motors today may be as high as 22 lbs./ft. Lock Torque, (or the equivalent of  $1\frac{1}{2}$  B.H.P. at 1000 r.p.m.) And the currents required to produce such high torques can be in the order of 400 amperes or more.

## SYMBOLS

We produce three main types of starters: the M35G., the M418G. and the M45G.

The letter "M" means in all cases *starter motor*: the number refers to the diameter of the yoke, and indicates that it is either 3.5",  $4\frac{1}{8}$ " or 4.5" in diameter. The final letter, as you can see, usually indicates some special feature, either a particular type of end bracket, a water-proofed machine etc.

## STARTER SYMBOLS

<b>PREFIX M</b>	—	<b>STARTER MOTOR</b>
35		$3\frac{1}{2}$ " DIAMETER
418		$4\frac{1}{8}$ " DIAMETER
45		$4\frac{1}{2}$ " DIAMETER
<b>SUFFIX A</b>		<b>PRESSED METAL C.E. BRACKET</b>
<b>G</b>		<b>DIE CAST C.E. BRACKET</b>
<b>L</b>		<b>LONG TYPE MACHINE</b>
<b>W</b>		<b>WATERPROOFED</b>

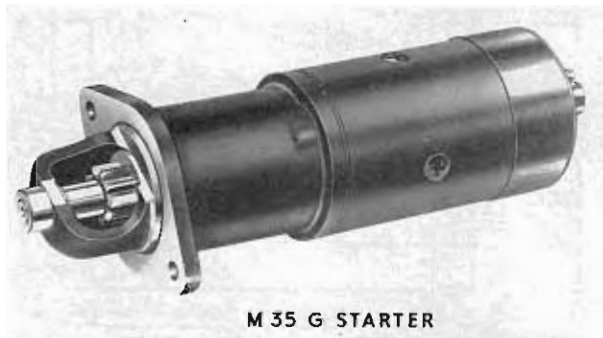

M 35 G STARTER



M 418 G STARTER

M 45 G STARTER

## THE M35G. STARTER

This machine is a 4 pole, 4 brush, series motor. It is produced either with the field coils wired in series or in series-parallel. The plain series arrangement is usually employed for the 12 volt machine, and the series-parallel for the 6 volt.

The highest torque available from these  $3\frac{1}{2}$ " models is approximately 9.3 lbs./ft. Lock Torque at 380 amps. for the 12 volt machine, and 6 lbs./ft. at 400 amps. for the 6 volt machine.

## THE M418G. AND M45G. STARTERS

Both these starters are 4 pole, 4 brush machines with series-parallel fields. This arrangement of the field coils produces an overall increase in the torque developed. The maximum Lock Torque figures for the M418G. type are:

17 lbs./ft. at 450 amps. for the 12 volt machine and 9.25 lbs./ft. at 520 amps. for the 6 volt machine.

For the M45G. i.e. the  $4\frac{1}{2}$  inch machine, the 12 volt range have a maximum Lock Torque of 22 lbs./ft. at 440 amps. and the 6 volt range of 14 lbs./ft. at 550 amperes.

In the next part we shall deal with the different types of drives used with the above range of starter motors.

# Starter Drives

## MAIN TYPES OF STARTER DRIVE

We have told you how the turning effort produced by the starter motor is transmitted to the engine flywheel by means of a starter drive and we shall now classify the various types, explaining the differences, both in construction and operation.

As far as the method of engagement is concerned,

starter drives fall into three main groups : the inertia or " crash " type, the pre-engaged type and the axial type.

For our purposes we shall deal mainly with the inertia drive, this being the type normally employed for cars and light commercial vehicles.

## THE "INERTIA " OR CRASH TYPE DRIVE

Here you see a simple " Inertia " or " Crash-Type " drive. As the starter armature rotates, quickly reaching a high speed, the pinion, lagging behind the movement due to inertia, slides along a screwed sleeve into mesh with the flywheel teeth.

The pinion and sleeve assembly is carried on splines on the armature shaft, this arrangement allowing the sleeve to move along the shaft against the action of a heavy compression spring, thus absorbing the initial shock of engagement. The pinion is thrown back into the disengaged position when the speed of the flywheel is relatively greater than that of the pinion, that is when the engine speed exceeds the motor speed.

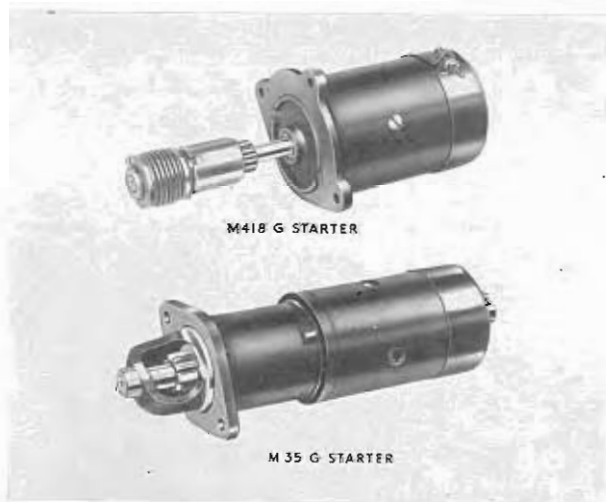

## INBOARD AND OUTBOARD OPERATION

According to the method of mounting, the pinion may be arranged to move towards the starter motor to engage the flywheel or away from the motor. The former arrangement is known as the *inboard* drive — that's the one you see at the top ; the latter is the *outboard* drive.

You will observe in the bottom picture that a special housing is necessary for outboard drives in order that an additional bearing can be provided to support the outer end of the shaft.

## FOUR MAIN TYPES OF STARTER DRIVES

Lucas make four main types of inertia drive : the S, SB, the RSB (rubber coupling) and the Eclipse, with inboard and outboard models of each type.

We shall now examine each type individually.

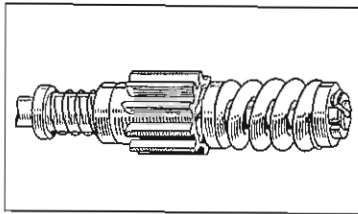
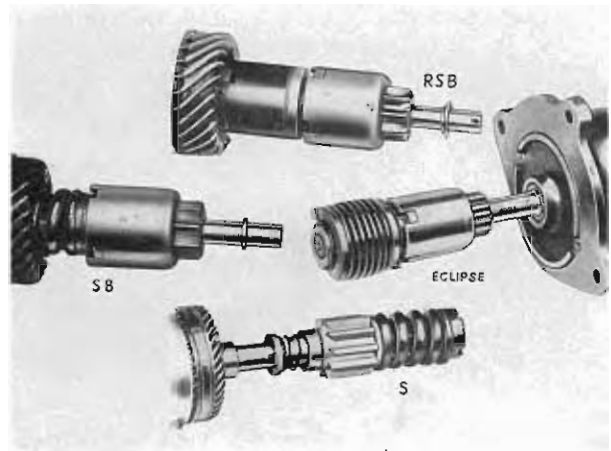

Inboard Pattern

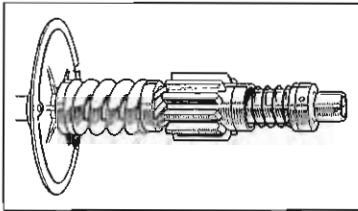

Outboard Pattern

### THE "S" TYPE DRIVE

The shock load is here absorbed by the heavy compression spring. A light retaining spring prevents the pinion from being vibrated into contact with the flywheel when the engine is running.

The pinion of the inboard drive moves in towards the starter motor, that is from right to left in this picture.

With the outboard drive the pinion moves outwards from the motor towards the end of the shaft.

### THE "SB" TYPE DRIVE

This drive is a later version of the "S" type you have just seen. The pinion is here carried on a barrel type assembly which is mounted on a screwed sleeve. This sleeve is carried on splines on the armature shaft and moves along the shaft against the action of a compression spring. The pinion retaining spring is incorporated in the barrel drive.

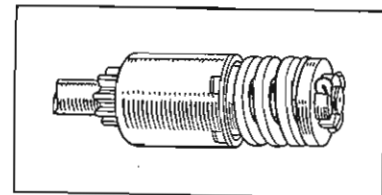

Inboard pattern

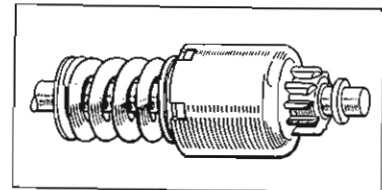

Outboard pattern

## RUBBER COUPLING DRIVES

There are three models of this type, the "RS" and "RSB" being for outboard meshing, and the "RE" for inboard and outboard.

All these types of drive embody a combination of rubber torsion member and friction clutch. These control the torque transmitted from the starter to the engine flywheel and dissipate the energy developed in the rotating armature of the starter at the moment when the pinion engages with the flywheel.

They also embody an overload release which functions in the case of extreme stress, such as may occur when the starter is inadvertently meshed into a flywheel rotating in the reverse direction.

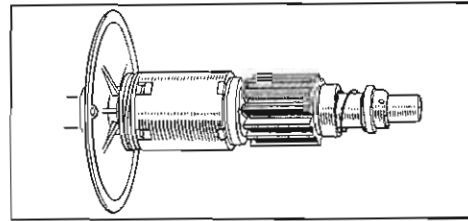

"RS" Pattern

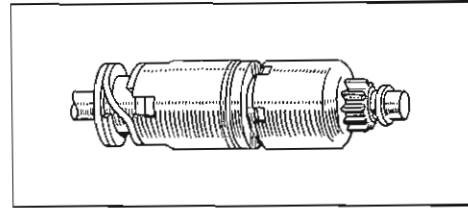

"RSB" Pattern

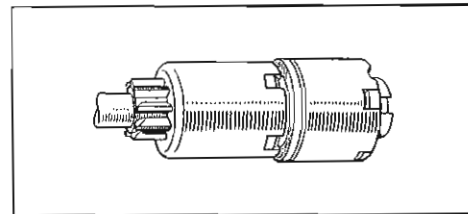

"RE" Pattern

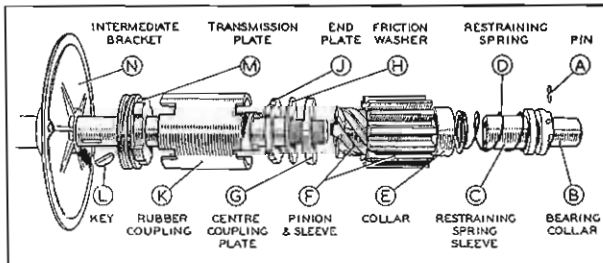

## THE "RS" TYPE DRIVE

When the starter is energised, the torque is transmitted to the pinion by two paths. One, from the transmission plate M, which is keyed on to the shaft, via the outer sleeve of the rubber coupling K and through the friction washer H to the screwed sleeve. The other path: from the transmission plate M to the outer sleeve of the rubber coupling, through the rubber to the inner sleeve and then via the centre coupling plate G to the screwed sleeve and hence to the pinion. The rubber limits the total torque which the drive transmits and, because the rubber is bonded to the inner sleeve, slipping can only occur between the rubber bush and the outer sleeve of the coupling. This slipping acts as a safety device against overload. Under normal conditions, the rubber will act as a spring and there will be no slip.

In all these drives, a pinion restraining spring D, is fitted, and this prevents the pinion from vibrating into mesh when the engine is running.

This particular drive is the RS pattern, but the principle of operation applies equally well to the other two types, the RSB and the RE.

## "RS" DRIVE — OUTBOARD

This is another picture of the RS drive and you'll notice that it is for outboard meshing.



RS

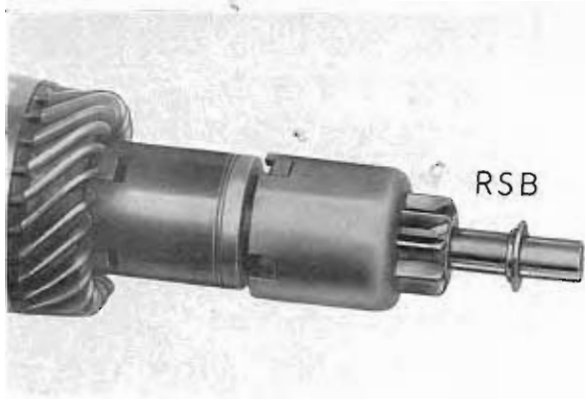

### “RSB” DRIVE

The RSB drive is again an outboard type. In this drive, a pinion and barrel assembly is used.

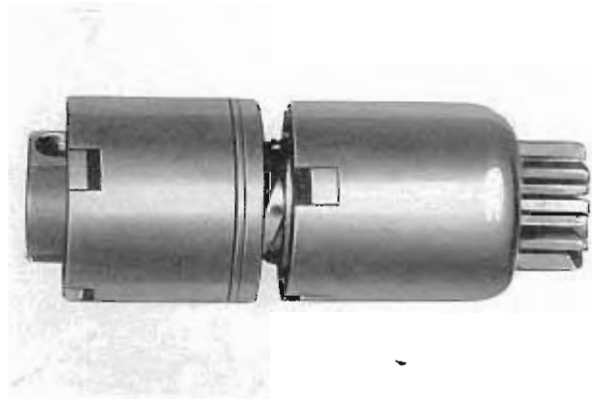

### “RE” DRIVE

The RE drive is the only one of the rubber coupling types built for both inboard and outboard operation. Again you'll remark that the pinion and barrel assembly is used.

### “ECLIPSE” DRIVE

The last main group of drives we have to deal with contains the “Eclipse” pattern. Here you have a general view of this drive, which is used for both inboard and outboard operation.

Basically it is a modified form of the “RE” drive, a main torsion spring, however, taking the place of the rubber.

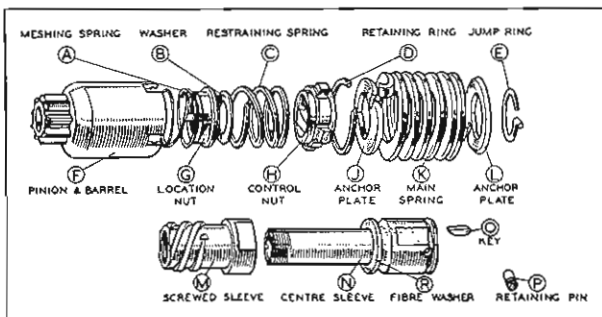
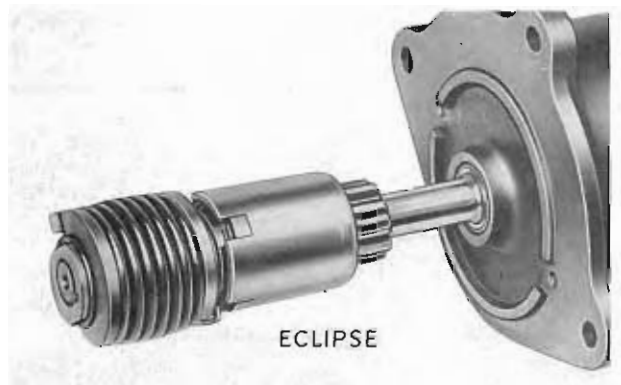

### “ECLIPSE” PATTERN DRIVE — EXPLODED VIEW

A meshing spring “A” (top left) and friction washer “R” (bottom centre) allow for slip under overload conditions.

The pinion is carried on a barrel type assembly which is mounted on a screwed sleeve “M” (bottom left). This sleeve is carried on a centre sleeve “N” and is secured to the armature shaft by means of a pin and key, “P and O.” The barrel assembly is so arranged that it can move along the shaft against the action of the “torsion” spring “K,” to reduce the shock loading at the moment of engagement. A pinion restraining spring, “C” is incorporated in the drive.

---

## PINION ENGAGEMENT

Before leaving the subject of starter drives, some reference should be made to the difficulties which sometimes arise with Starter engagement.

You can be assured that before any engine goes into general production, the engine manufacturer has satisfied himself that the Lucas starter which he has selected — generally in collaboration with our Sales Engineers — is suitable for that engine.

It sometimes happens however, that the assembly tolerances for instance, which finally determine the position of the leading edge of the flywheel teeth in relation to the starter motor pinion, do not work out quite as expected, resulting in starting troubles in service. The starter pinion may have to travel too far, thus developing a high speed before engaging the flywheel teeth, with the result that “milling” or “chipping” of the teeth takes place.



### COMPARING A NEW AND WORN PINION

You can see in this picture how badly the teeth of one of the pinions have been damaged.



### FLYWHEEL RING — NORMAL WEAR

These flywheel teeth show no more than normal wear after prolonged service.

## OUT OF MESH CLEARANCE

If the distance between pinion and flywheel is correct, no abnormal wear of the teeth takes place, the pinion sliding into mesh with little preliminary rotary movement. This distance, when the pinion is in the disengaged position, is called the "out-of-

mesh" clearance.

We show both an outboard and inboard type arrangement here, the difference between measurement "A" and "B" being in each case the out-of-mesh clearance.

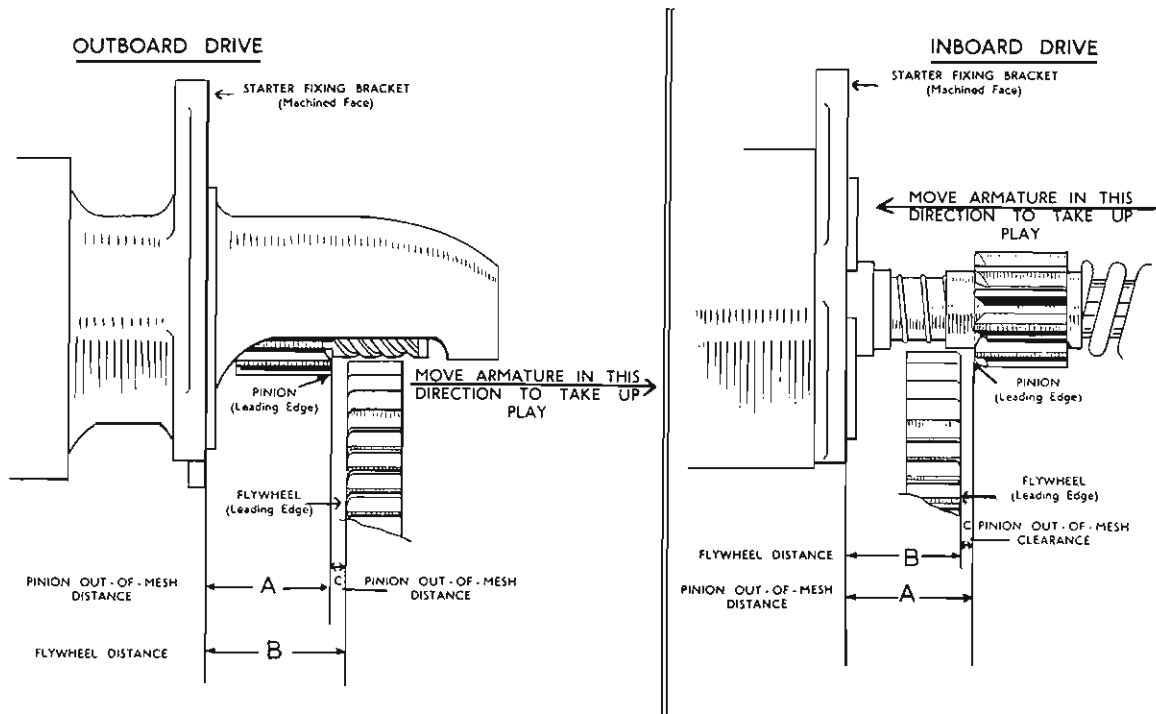

## MEASURING OUT-OF-MESH CLEARANCE

The method of measuring the clearance is shown in this illustration.

First take the dimension in the left hand picture, that is the distance between the starter — flange face and the leading edge of the pinion teeth. Then, as in the picture on the right, measure the distance from the machined face on the clutch housing to the flywheel ring gear. A properly calibrated depth gauge should be used to ensure accurate measurement.

The first measurement should then be subtracted from the second.

The correct clearances for the various types of drive are :—

Eclipse Type	..	..	$\frac{1}{16}$ " to $\frac{3}{16}$ "
All other types	..	..	$\frac{3}{32}$ " to $\frac{5}{32}$ "

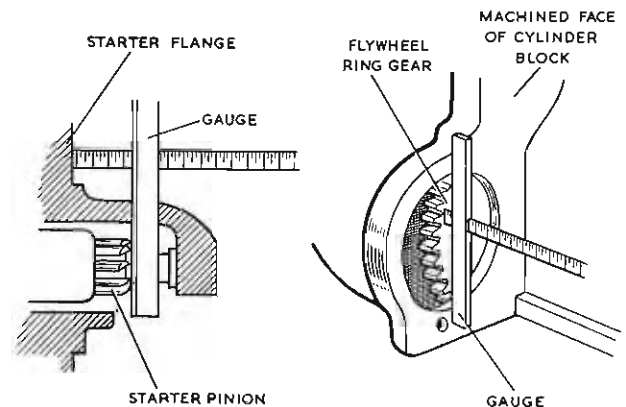

## EXCESSIVE ARMATURE END FLOAT — SHIMMING

Even if the clearance was originally correct, if, in the course of service, excessive end-float is allowed to develop in the armature shaft, the out-of-mesh clearance may be sufficiently increased to cause trouble.

If noisy starter operation is experienced, the armature end-float of the starter should be checked, and if found to be excessive, shims should be inserted to take up the play. In the case of outboard starters, shims should be inserted at both the commutator and drive ends. In the case of inboard machines, the drive end only is shimmed.

Ten-thousandths (.010) of an inch end float is normal, but if more than .015, the out-of-mesh clearance may be affected, and any excess should be taken up.

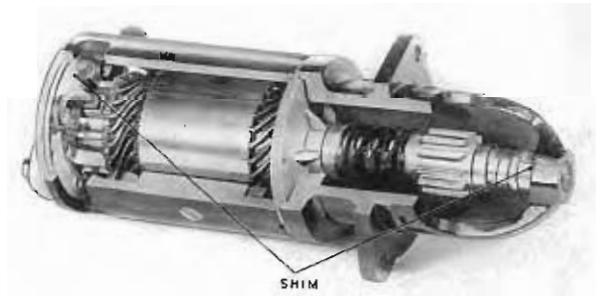

## FAULTY ENGAGEMENT AND DIS-ENGAGEMENT

Faulty engagement as a general rule is the result of allowing the screwed sleeve and pinion assembly to become rusty or choked with grease or dirt and this may be easily rectified by a clean-up and re-lubrication with a light machine oil. It is particularly important to use a light machine oil under low temperature operating conditions when the motor acceleration may be reduced owing to the heavy current taken by the motor.

Other reasons for failure to engage may be broken or distorted Restraining Springs, broken or contracted main springs, faulty re-assembly of the complete drive after servicing, or incorrect out-of-mesh clearances.

As far as faulty disengagement is concerned, we will content ourselves with listing the likely causes.

Sticking of the pinion in mesh with the flywheel can be caused by :—

- (1) Bent armature.
- (2) Worn screwed sleeve, which causes the pinion to stick along the thread.
- (3) Dirty or rusty condition of the sleeve and pinion.
- (4) Slack drive assembly, usually due to the weakening of the compression spring.
- (5) Incorrectly adjusted switch operating cable.

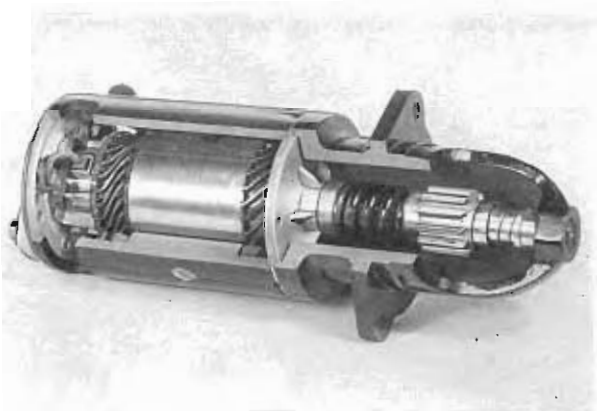

## ASSEMBLY AND LUBRICATION OF DRIVES

These other points should not be overlooked if the mechanical side of the starting operation is in any way suspect.

First, the assembly of the drive. The unit may have been dismantled and reassembled incorrectly, in which case the best results can hardly be expected. And secondly the drive may be dry or dirty. A clean drive, lightly oiled, will give efficient operation.



# Service Testing on the Vehicle

## STARTER CIRCUITS

Having dealt mainly with the mechanical aspects of starting and starter motors, we shall now discuss the electrical side, showing you various starter circuits and finishing with a comprehensive series of tests for proving the electrical system.

Fundamentally the starter circuit is extremely simple as you can see, consisting of the feed wire from the battery to the starter motor, the circuit being controlled by a switch. The return path is via the chassis.

Lucas produce several types of starter switch. The one represented here is the simple manually-operated pull or push type.

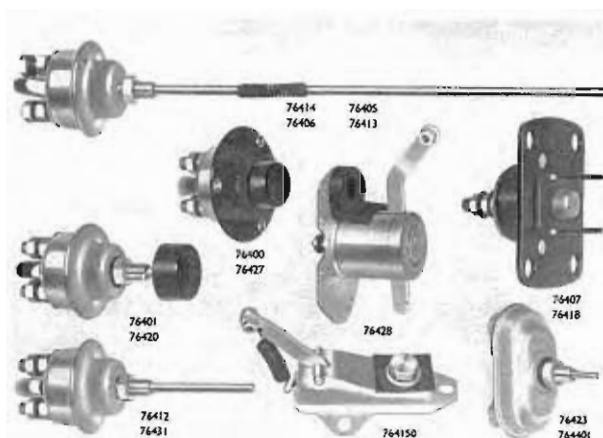
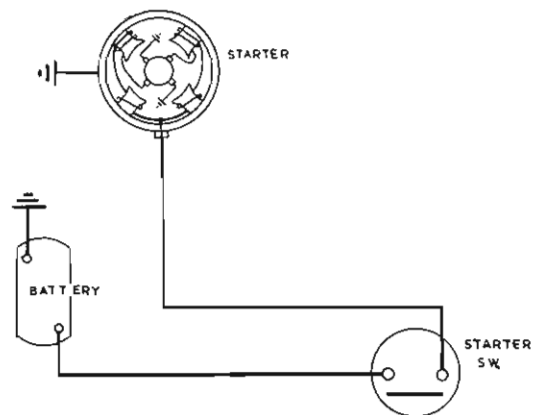

## MANUALLY OPERATED STARTER SWITCHES

Several examples of the manually operated switch are shown here.

Each type, of course, is capable of passing the heavy current required by the starter motor, without voltage loss.

The effective life of any of them depends mainly on two factors: that the contact should be clean and positive; and that the break should be quick, with sufficient travel.

## SWITCH ADJUSTMENT

Where the switch is operated by Bowden Cable, it is extremely important that the pull is correctly adjusted. Otherwise excessive burning of the contacts takes place, with resultant loss of starter performance. There is a danger also, that with a too close adjustment of the switch contacts, the starter motor may be vibrated into operation. There should be about  $\frac{1}{8}$ " free movement in the cable before the switch lever is moved.

The Push type switches are spring-loaded and require no adjustment.





### "G" TYPE END BRACKET

Where this "G" type end bracket is used, the two fixed contacts must be faced to ensure correct alignment for the moving contact.

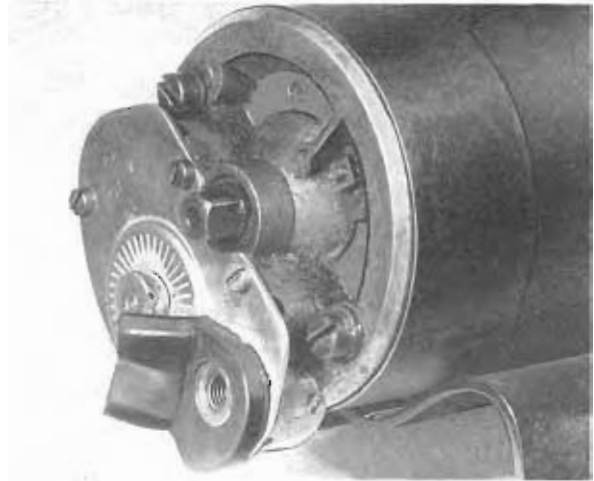

### END BRACKET — BLANKING PLATE

We now mount the starter switch separately, thus enabling us to produce a standard type of end bracket. Many starters with "G" type end brackets are still, however, in service and for these a "blanking-off" plate is used which carries a disc contact to bridge the two fixed contacts.

This arrangement enables the separately mounted switch, usually of the solenoid type, to be used.

### STARTER SOLENOID SWITCH

The electrically operated switch or solenoid is shown here.

It contains the main starter contacts which are closed magnetically when the relay winding inside the switch is energised — that is when the starter push on the dashboard is pressed.

One end of this winding is connected to the smallest of the three terminals, and the other end to the metal case, which is earthed when the solenoid is bolted to the metalwork of the vehicle.

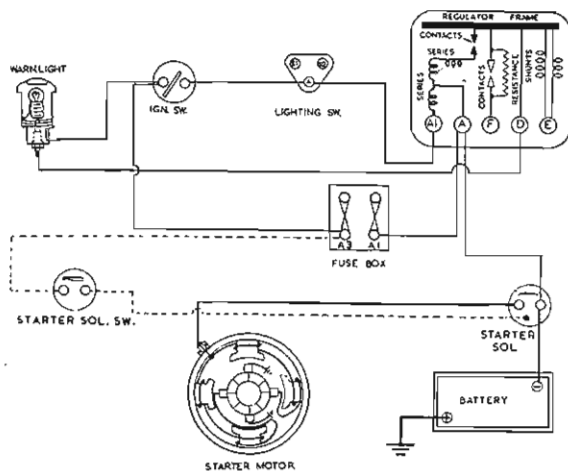

### CIRCUIT FOR SOLENOID OPERATED STARTER

In the normal circuit, the feed to the solenoid operating push is taken effectively from the ignition switch ; A3 on the fuse board being used here only as a junction point. You'll notice there is *no* fuse in circuit. The cable from the negative of the battery is taken direct to one of the main solenoid terminals, the other main terminal being connected to the starter motor. The circuit is again completed via the starter and battery earths.

## TESTING THE STARTER SYSTEM

From the earlier parts of our talk you may have gained the impression that starting troubles are mainly mechanical in origin — far from it. Trouble may often be traced to electrical causes : either to a faulty battery, a bad connection in the circuit or to a poor contact at the switch. It should never be assumed when faced with total failure or sluggish operation of a starter motor, that the fault lies necessarily with the motor itself.

It is therefore imperative that a systematic series of checks be first carried out on the electrical circuit so that the fault may be localised.

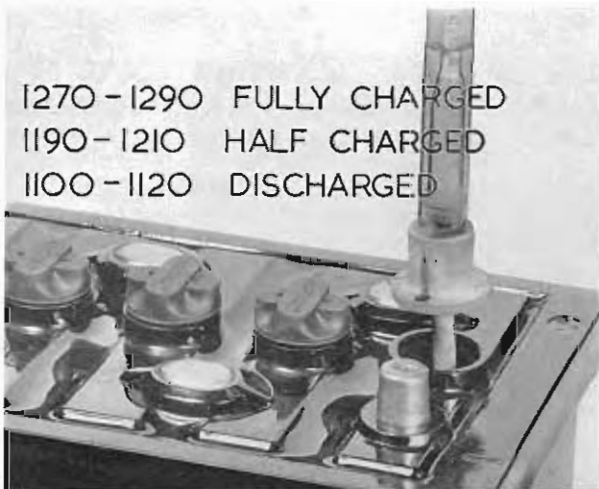

### BATTERY CHECK — HYDROMETER TEST

The hydrometer should show an evenly charged battery, that is, no great variation in cell readings, and *at least* a half-charged condition.

## CHECKING PROCEDURE

We shall tackle the job in this order :

- (1) Battery check.
- (2) Voltage at the Battery.
- (3) Voltage at the Starter.
- (4) Voltage drop on Main Line.
- (5) Checking starter switch.
- (6) Voltage drop on Earth Line.



### BATTERY CHECK — HEAVY DISCHARGE TEST

As a further check for the battery, a heavy discharge tester should be applied for approximately 15 seconds to each cell.

Steady readings of approximately 1.5v. per cell indicate a serviceable battery. A falling reading will be obtained from any cell which is defective.

We have thus made sure that the battery is at least capable of giving the heavy current required by the starter motor.

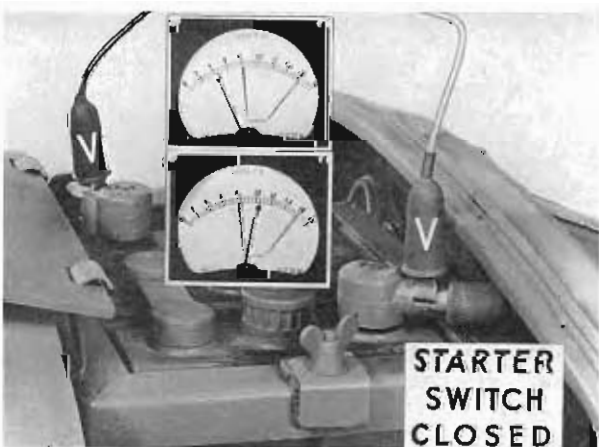

### VOLTAGE AT THE BATTERY TERMINALS

And now, the rest of the circuit. The first check will give us the working voltage or pressure at the battery. The voltmeter is connected between positive and negative terminals.

When the starter is operated on a *cold engine*, the readings should not fall below 10 volts for the 12 volt system and 4.5v. for the 6v. system.

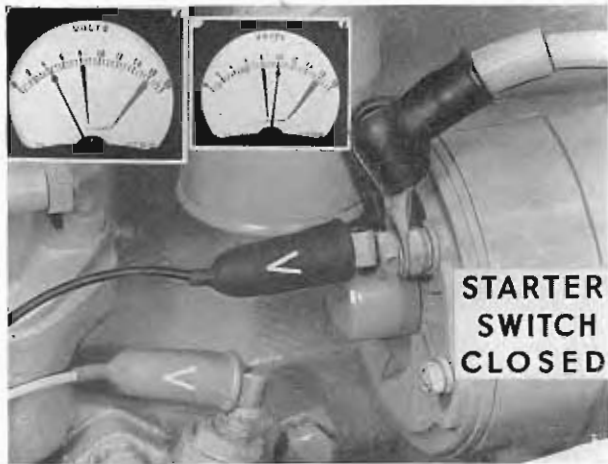

### VOLTAGE AT STARTER TERMINAL

Assuming the voltage at the battery to be in order, next check the voltage at the starter terminal. This should be no more than .5v. lower than the previous reading. *The voltmeter is connected between the starter terminal and the starter yoke.* In this photograph, the bottom voltmeter lead should NOT be connected where it is — there may be a bad connection between the engine block and the starter yoke.

If a low reading had been obtained, both at the battery in the previous test and at the starter terminal, the motor is taking too much current, and the trouble will be found in the starter motor itself.

A good voltage at the battery and a poor voltage at the starter i.e. a considerable voltage drop, indicates a high resistance somewhere in the circuit.

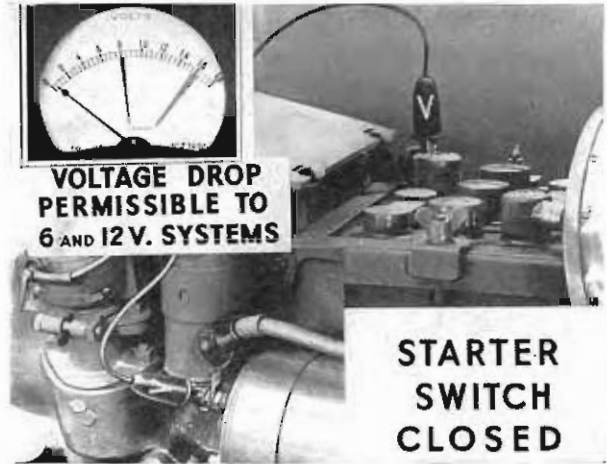

### VOLTAGE DROP ON THE INSULATED LINE

For our next test, we connect the voltmeter between the starter terminal and the main battery post to check the voltage drop on the insulated or feed line.

Before the starter switch is closed, battery voltage should be registered. But on closing the switch, the reading should fall to zero ; but readings of up to .5 volt are permissible in service. If a higher voltage is registered, a high resistance point somewhere along the line is indicated. The most likely place is at the switch contacts.

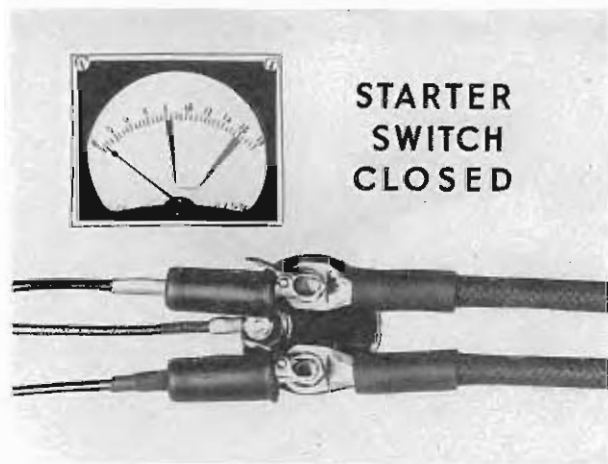

### CHECKING THE SWITCH CONTACTS

The contacts can be checked by connecting a voltmeter across them and closing the switch. The reading of battery voltage should fall immediately to zero or within .5 volt of zero.

If the reading is within this limit, the high resistance deduced in the last test must be due either to a loose or corroded terminal, either at the battery or starter switch or at the starter motor. All of these points can easily be checked by a visual examination.

## VOLTAGE ON EARTH LINE

In this last test, we are checking for voltage losses caused by a high resistance point on the earth return side of the circuit.

The voltmeter is connected between the battery earth terminal and the starter yoke. If the earth line is in order, the voltage drop when the starter is operated will be zero.

In service, a voltage drop of .5 volt is permissible.

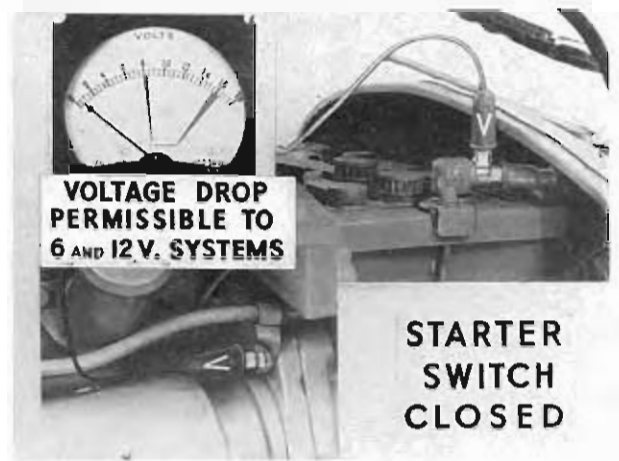

## THE EARTH CONNECTION

If a substantially higher reading is obtained, all earth connections in the starter circuit must be checked.

Using the voltmeter as we have shown, each connection must be proved electrically sound.

The most frequent cause of voltage drop on the earth line is a bad connection where the lug is earthed. Make sure that any such connection is clean and tight. Be particularly wary if the vehicle has just been repaired or painted; the connection may have been disturbed.

## THE BONDING STRIP

Another likely trouble spot is at the "bonding strip" between the engine block and the chassis. Remember that modern engines are rubber-mounted, the only good electrical connection to the chassis often being made by means of this strip.

Sluggish operation of the starter and sometimes complete failure can be caused by such a fault, or by a combination of minor losses at different points which produce in one circuit a sufficiently serious voltage drop to affect the performance of the starter motor.

We hope we have proved our point: don't suspect the starter before you have tested its electrical supply. Like most of us, it won't work if it's not fed properly.

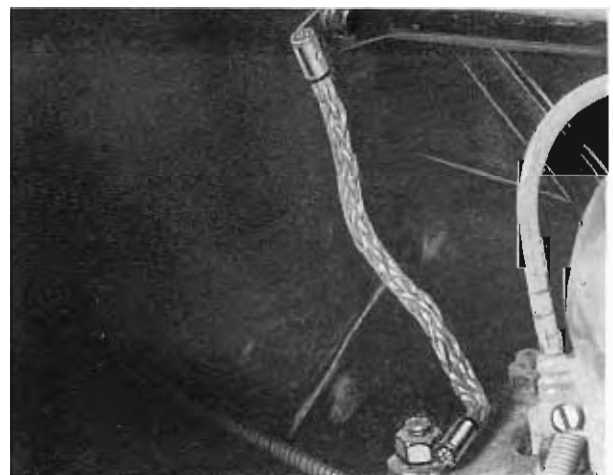

# The Lucas M45G Pre-engaged Starter

## GENERAL VIEW—MANUALLY OPERATED PRE-ENGAGED STARTER

The majority of Lucas starters are equipped with the inertia or "crash-type" drive. In this arrangement, the starter motor is first energised, the revolving armature then forcing the pinion along a screwed sleeve into mesh with the engine flywheel.

The pre-engaged starter we feature here employs a different method of engagement: as its name implies, the pinion is actually in mesh with the flywheel ring gear prior to the torque being applied.

This type of engagement is more suitable for heavier engines of the diesel type, where large flywheels, high compression ratios and generally higher cranking speeds are usual. A normal inertia drive would quickly be damaged when operating under these conditions; the meshing impact of the driven-pinion on a comparatively solid flywheel would be far too great to give an adequate service life for the starter motor.

The pre-engaged starter is basically similar to the Standard M45G motor, with a different drive assembly, and a Pilot Switch.

## CROSS SECTION OF STARTER AND FLY-WHEEL

The position of the pilot switch in relation to the drive assembly is visible in this illustration.

When the starter operating rod is moved into the starting position, the operating lever attached to the end of it slides the pinion along the armature shaft into mesh with the flywheel ring gear. In this picture, the movement is just beginning. When the pinion has travelled the correct distance, the operating lever will close the pilot switch contacts. This completes the circuit for the energising winding of the starter solenoid, thus closing the main starter contacts. The starter armature revolves, transmitting the cranking torque via the pre-engaged pinion to the fly wheel.

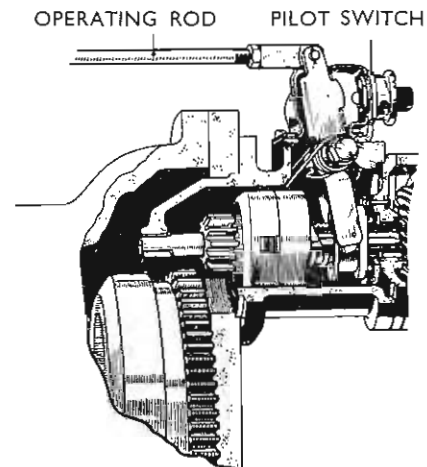
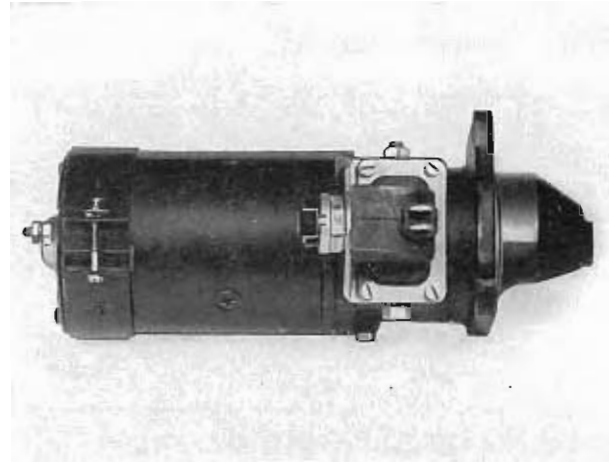

SECTIONED VIEW OF STARTER AND BELL-HOUSING  
Showing starter operating rod in position

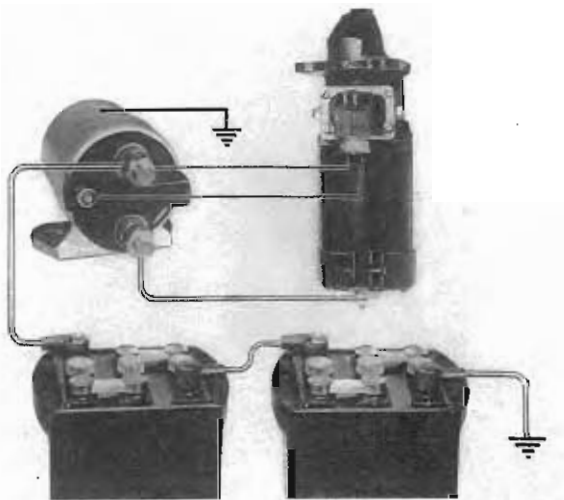

## THE COMPONENTS CONNECTED IN CIRCUIT

We have connected the components in circuit here to give a general idea of the layout.

We will assume that the starter pinion has just been pushed into mesh with the flywheel. *The pilot switch contacts* will thus be made and the circuit for the energising winding of the solenoid completed. Commencing at the battery earth, this circuit is as follows:—through the two 6 volt batteries to one of the main solenoid terminals which is connected to one side of the pilot switch. Current passes across the switch contacts to the small solenoid terminal. The energising winding is connected between this terminal and the case which, as you can see, is earthed. The circuit is thus returned to the battery.

When the solenoid operates, the plunger closes the main contacts in the starter supply line, thus energising the starter in the normal way.

## THE WIRING CIRCUIT

The internal and external connections can be seen from this circuit.

The study of this picture will be simplified if you divide the circuit into two : first, the relay operating circuit ; secondly, the main current circuit.

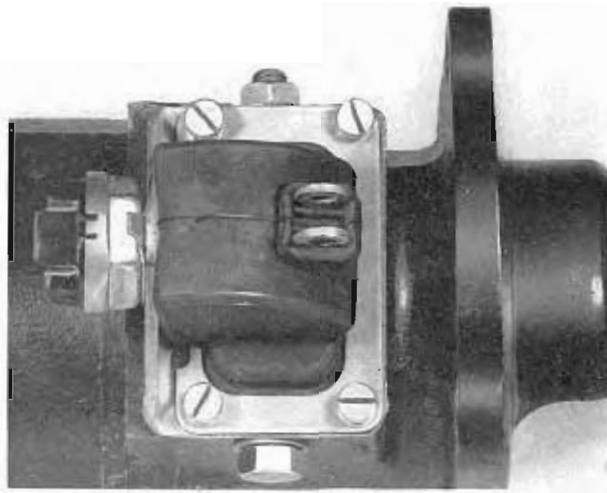
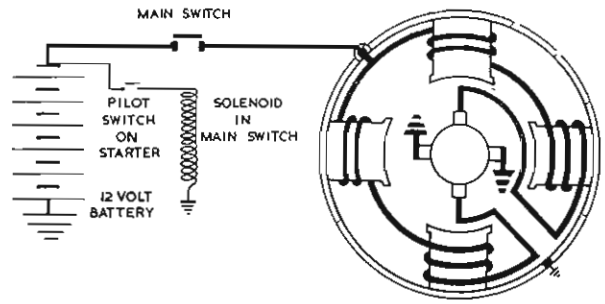

## THE PILOT SWITCH AND RUBBER SHROUD

This close-up shows the pilot switch with its two grub screw connections. The switch plunger is actuated by the operating lever when the starter rod is moved.

The switch assembly is fixed to the starter body by four set screws, which also serve to fasten the water-proofing rubber shroud in position.

The switch bracket is slotted so as to allow adjustment of the switch in relation to the operating lever. We shall be referring to this adjustment more fully later on.

## THE ARMATURE BRAKE

Let us now make a more detailed examination of the mechanical operation of this starter.

In the rest position, the bottom of the operating lever holds a brake plate hard against a brake lining. You can see the coiled springs which provide the tension. The plate is carried on the splines of the armature shaft and the brake lining rivetted to the intermediate bracket. The armature is thus prevented from rotating when the plate and lining come into contact.

Consider for instance a case where the starter is operated and the engine fires, but then stops ; the starter pinion could possibly still be revolving when it was again meshed into the flywheel. The coiled springs prevent this by returning the operating lever to the rest position and in so doing, a braking effect is applied to the armature.

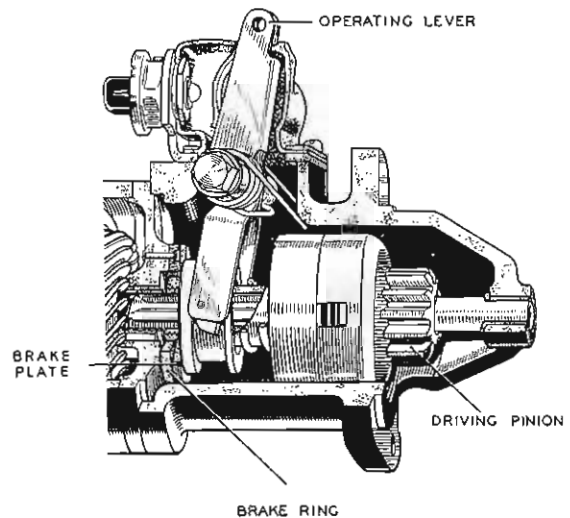





### THE OPERATING LEVER

The stirrup shaped end of the operating lever is visible here so are the coiled springs holding it under tension. The two toggles actually form the bearing member on to the brake plate.

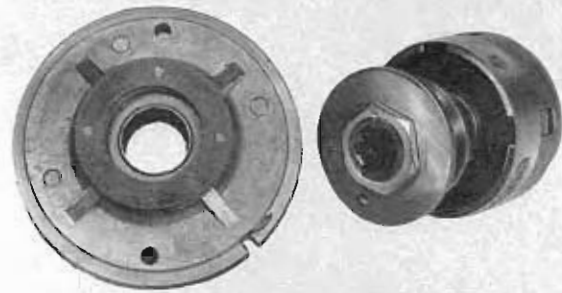

### THE BRAKE LINING AND BRAKE PLATE

And here you see, on the left, the brake lining attached to the starter intermediate bracket.

On the right, we have photographed the brake plate in position at the end of the drive assembly.

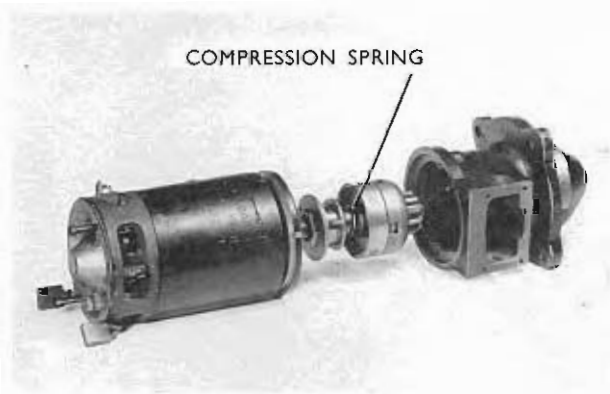

### THE COMPRESSION SPRING

The next feature of the drive assembly we wish to discuss is the compression spring. This is situated immediately behind the pinion and barrel assembly.

Usually, the pinion and flywheel mesh without any difficulty, the teeth being chamfered at the leading edges to ease the engagement. It can happen however that the teeth butt against one another — this is known generally as “tooth to tooth” engagement. When this occurs, the pinion will not slide into mesh but remains tight against the flywheel teeth. Increased pressure must be applied to the starter operating rod. This compresses the heavy spring behind the pinion and barrel, the compression continuing until the pilot switch contacts are closed by the operating lever. The spring can be more clearly seen in the exploded view below. The armature then begins to turn and immediately the pinion is sprung into mesh.

### THE CLUTCH

A clutch mechanism is incorporated in the drive to avoid overloading the starter. It is housed in the barrel of the pinion and barrel assembly.

Immediately the armature begins to turn, a heavy steel ring slides along a fast thread compressing the clutch plates and transmitting the drive to the pinion and barrel.

If the pinion sticks in mesh and the flywheel attempts to drive the starter motor, the steel compression ring returns along the fast thread to the rest position, leaving the clutch plates slack so that no drive can be transmitted through them.

If, to take another case, the engine load is too great, such as when the vehicle is in gear and the starter motor attempts to turn over the engine, the clutch is arranged to slip, thus relieving any abnormal strain on the motor. This slipping will also protect the

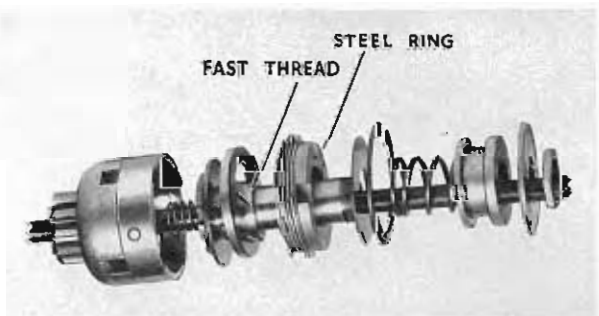

starter should the engine backfire. The clutch is set during manufacture to slip in the driving direction at two to three times the normal full load torque and should never normally need re-adjustment in service.





### PILOT SWITCH ADJUSTMENT

You will appreciate that the position at which the operating lever closes the switch contacts is rather critical if the pinion engagement is to be trouble free. Provision is therefore made for adjusting the position of the switch plunger with respect to this lever.

The four set screws, visible in the picture secure the cover plate and at the same time lock the adjusted switch in position.

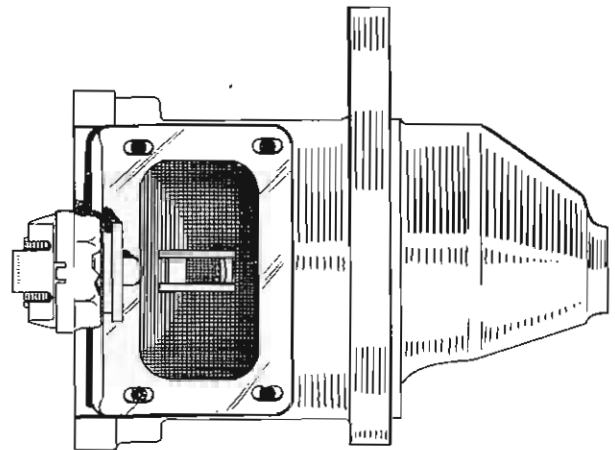

### THE ADJUSTING HOLES

This shows the elongated adjusting holes when the cover has been removed.

### PROCEDURE FOR ADJUSTING SWITCH

In service, the adjustment of the switch should be carried out with the starter motor removed from the vehicle.

The pilot switch should then be set to make electrical contact when the leading edge of the starter pinion is from  $1\frac{5}{8}$ " to  $1\frac{3}{4}$ ", as specified for individual vehicles, from the machined face of the drive end bracket. The switch fixing screws should be temporarily loosened and the operating lever pressed until the correct distance is reached. The switch can then be moved forward so that the plunger engages with the operating lever.

We suggest that a test lamp and battery be connected in series with the switch so as to facilitate finding the exact position at which the plunger closes the contacts.

When the motor is re-fitted, care must be taken to see that the starter operating linkage on the vehicle is correctly adjusted. There should be no slack in the movement ; on the other hand, full travel of the operating lever must be assured.

### MAINTENANCE

The pre-engaged starter needs no further attention in service beyond that given to normal starter motors. An inspection of the brush gear and commutator, together with a check of the external electrical connections and cabling, should form part of the normal routine maintenance.

